

MARCH, 1927

25 CENTS

RADIO

(REG. U. S. PATENT OFF.)

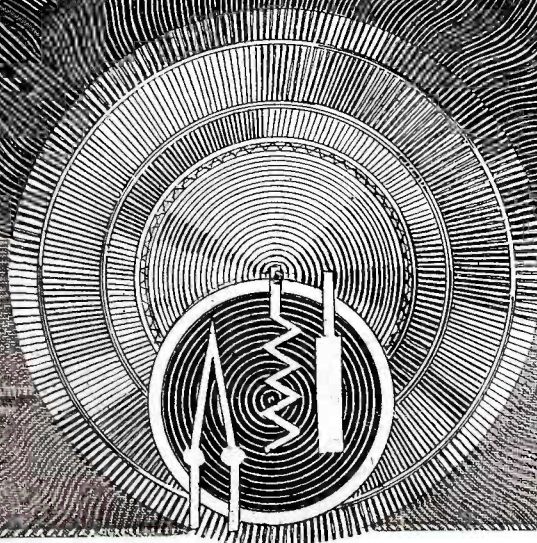
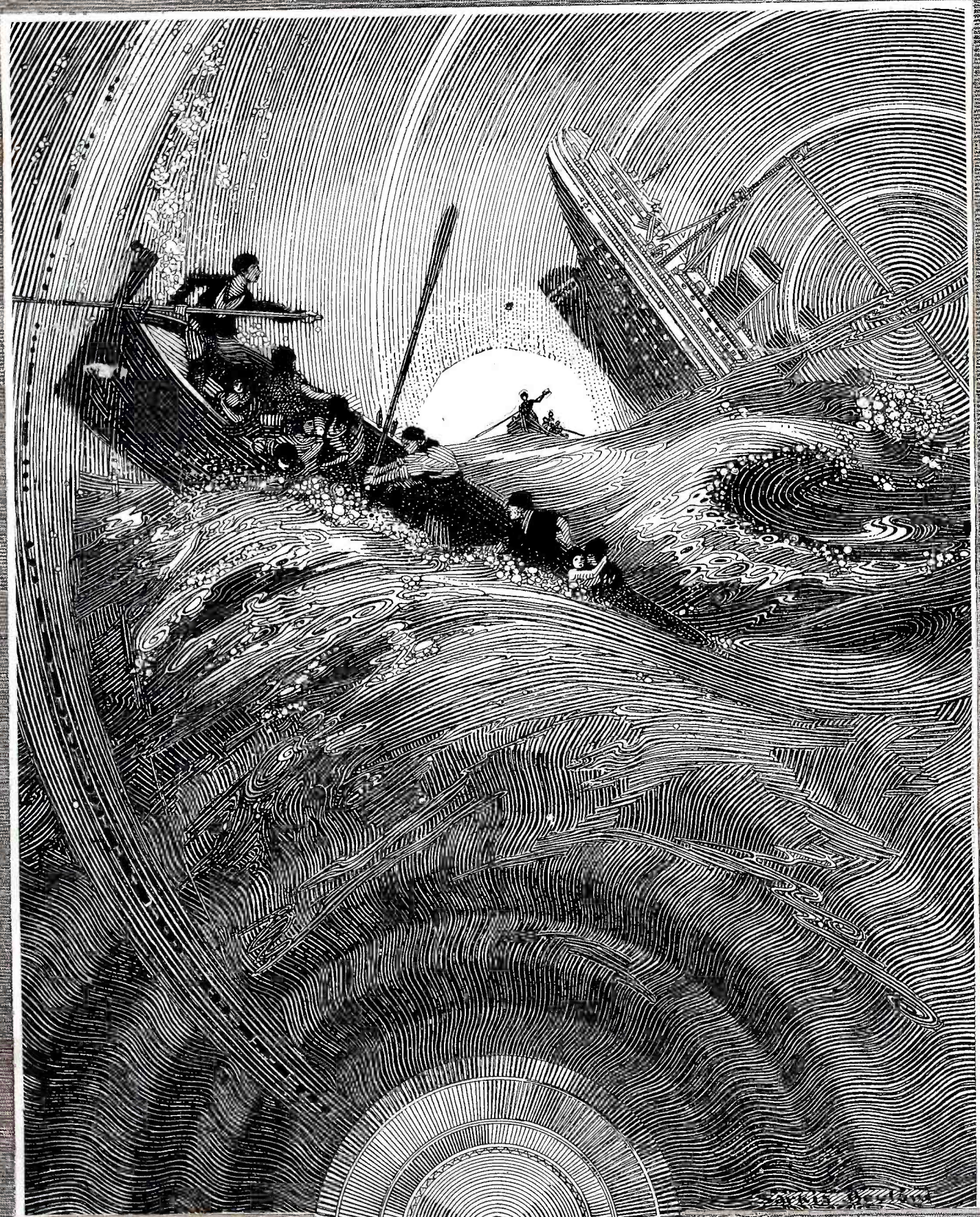

Cunningham RADIO TUBES

Since 1915 —
Standard for all Sets



Every Time You Face The Dial

of your receiver, it is in anticipation of real radio enjoyment if Cunningham Radio Tubes are on duty behind the panel. Confidence in the product bearing the Cunningham name has become an habitual attitude of mind among radio-owners of discrimination.

Fifteen Types all in the Orange and Blue Carton

E. T. CUNNINGHAM, Inc.



C-376



C-377



NEW YORK

CHICAGO

SAN FRANCISCO

Manufactured and sold under rights, patents and inventions owned and/or controlled by Radio Corporation of America.

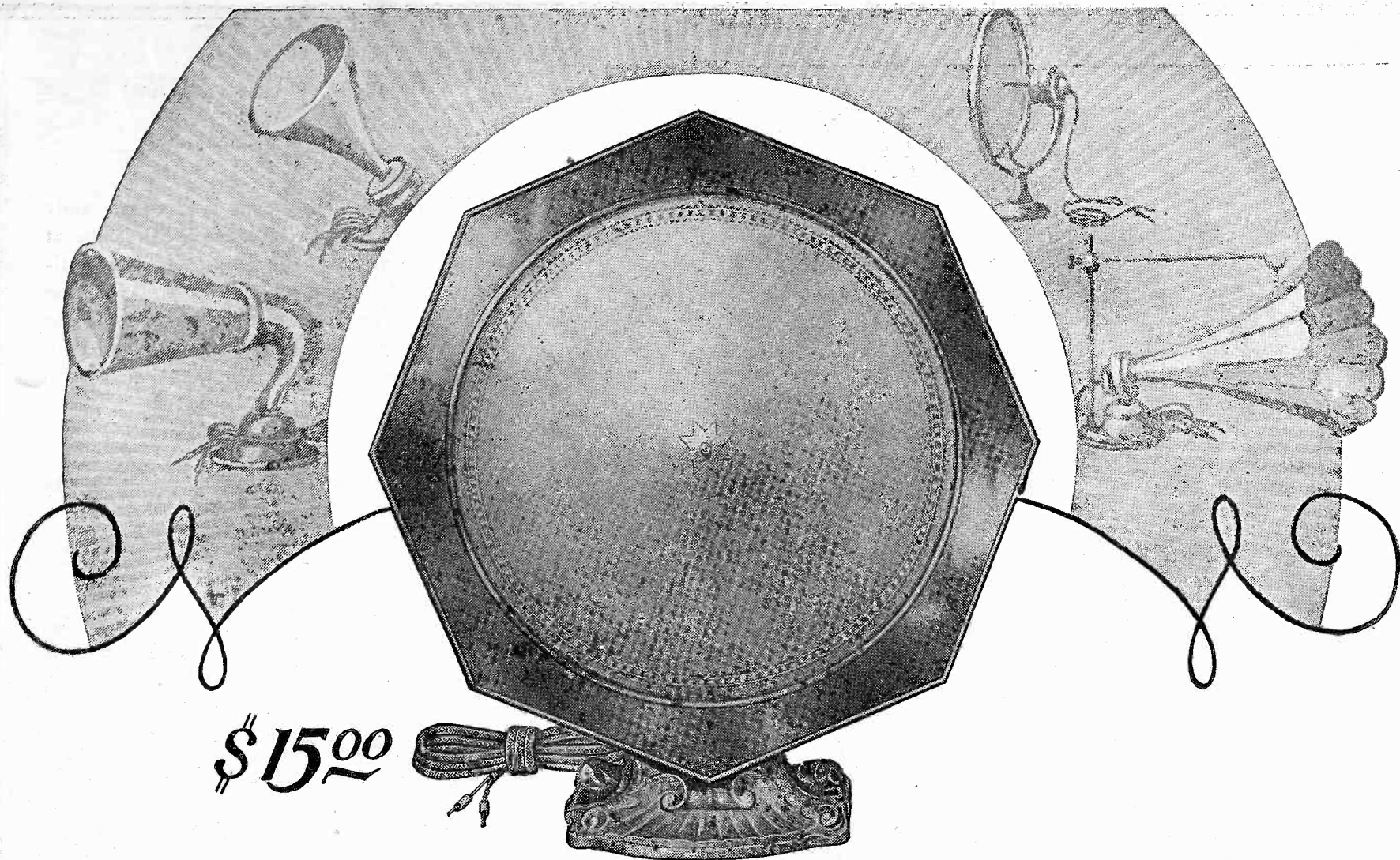

PROGRESS

REMEMBER the first loudspeakers? — they looked like megaphones and sounded worse. And remember the prices. Oh boy!

Certainly, tremendous strides have been made in radio acoustics as well as in appearance. Yet most prices remain entirely too high — at least they did until Tower entered the field.

Now, you can buy a speaker of highest quality, such as the new Meistersinger, for only \$15. This cone may be used as a Wall or Table model, according to taste or space requirements. Its powerful direct-drive unit with *eight* connections to cone (*Patented*) delivers a tone quality and volume usually associated only with speakers much higher in price. Other Speakers—each a leader in its class—from \$4.95 to \$9.50.

*On Sale from Coast
to Coast*

TOWER MFG. CORP.,
Boston, Mass.

Tower
Meistersinger
CONE

RADIO FOR MARCH, 1927

RADIO

With Which Is Incorporated "Radio Journal"

Established 1917

Published Monthly by the Pacific Radio Publishing Co.

ARTHUR H. HALLORAN
Editor

GERALD M. BEST,
Technical Editor

H. W. DICKOW,
Advertising Manager

Branch Offices:

New York City, 20 East 42nd St.
Chicago, 307 N. Michigan Ave.
Boston, 86 St. Botolph St.
Kansas City, Mo., Davies & Dil-
lon, 707 Land Bank Bldg.

Rates:

Issued Monthly, 25c a copy.
Subscription price, \$2.50 per year
in the U. S., \$3.00 per year else-
where.

Correct Addresses:

Instructions for change of address
should be sent to the publisher
two weeks before the date they
are to go into effect. Both old
and new addresses must always be
given.

Advertising:

Advertising Forms Close on the
First of the Month Preceding
Date of Issue.

Member Radio Magazine Publishers' Association
Entered as second-class matter at Post Office at San Francisco, Calif.
Copyright 1926 by the Pacific Radio Publishing Co.

Address all communications to

Pacific Radio Publishing Company

Pacific Building, San Francisco, California

VOLUME IX

MARCH, 1927

NUMBER 3

CONTENTS

	PAGE
RADIOTORIAL COMMENT	9
HOW AMATEUR RADIO SCOOPED.....	10
<i>By Don C. Wallace</i>	
INFRADYNE TIPS	12
<i>By E. M. Sargent</i>	
WHAT PRICE TONE QUALITY.....	13
<i>By S. R. Winters</i>	
A SOCKET POWER OSCILLATOR.....	14
<i>By Boris S. Naimark</i>	
THE BROWNING-DRAKE RECEIVER.....	15
<i>By Glenn H. Browning</i>	
A. C. OPERATION OF THE 1927 BEST SUPERHETERODYNE.....	17
<i>By G. M. Best</i>	
THE AMPLIFIED GOD	19
<i>By B. W. Wilson</i>	
HOW TO BUILD THE R. G. S. INVERSE DUPLEX.....	20
<i>By David Grimes</i>	
RADIO PARTS SALVAGE.....	22
<i>By Willis L. Nye</i>	
TRACING SUPERHETERODYNE DIAGRAMS.....	23
<i>By Lester I. Wiltze</i>	
EXPERIMENTAL SHOP ACCESSORIES AND METHODS.....	26
<i>By Samuel G. McMeen</i>	
A PHONOGRAPH CABINET RECEIVER.....	27
<i>By Perry S. Graffam</i>	
SOME RADIO POINTERS.....	28
<i>By Harry A. Nickerson</i>	
THE ULTIMAX RECEIVER.....	29
<i>By C. W. Morris</i>	
TRICKLE CHARGERS	31
<i>By G. M. Best</i>	
THOSE BARGAIN SALE RECEIVERS.....	33
<i>By E. F. Kiernan</i>	
QUERIES AND REPLIES.....	34
BOOK REVIEWS	35
THE COMMERCIAL BRASS POUNDER.....	36
WITH THE AMATEUR OPERATORS.....	38
AN IMPROVED COIL FOR SHORT-WAVE RECEPTION.....	38
BRAZILIAN QRA's	39
FROM THE RADIO MANUFACTURERS.....	58

Forecast of Contributions for April Issue

J. E. Anderson has made a thorough study of the characteristics of a High Mu Tube at Work. He presents the results of his investigation in the form of a series of interesting curves with explanatory text which show the necessity for negative grid bias in order to secure full distortionless amplification.

— : —

Kirk B. Morcross asks and answers the question "Do Waves Interfere?"

— : —

C. T. Burke explains the use of a quartz crystal as a standard in the calibration of a wavemeter. The technique employed is covered so completely that any amateur experimenter can do likewise.

— : —

Geo. Baxter recites some interesting history of early-day Pacific Coast wireless in an illustrated article dealing specifically with the recent passing of the Beach station at San Francisco.

— : —

R. R. Redfern discusses the behavior of r.f. transformers with vacuum tubes as amplifiers. This information is presented in a form which will be useful to the average set-builder.

— : —

A new tuned r.f. set having single control and using shielded coils has been especially designed in RADIO's laboratory by G. M. Best who gives most complete details regarding its construction.

— : —

Continuing his articles on experimental shop methods, Samuel G. McMeen recommends certain minor tools which will be found useful in a shop equipped as herein previously described. These include hack-saws, scales, screw-micrometers, mathematical aids, guides, and a home-made galvanometer.

— : —

Paul Oard gives some radio construction pointers which include data on variable condensers, bus wiring, and a large number of useful kinks.

— : —

The fiction feature is a clever radio detective story entitled "Science vs. Common-Sense" by Philip N. Emigh.

Insist on hearing **R.G.S.** *this receiver*

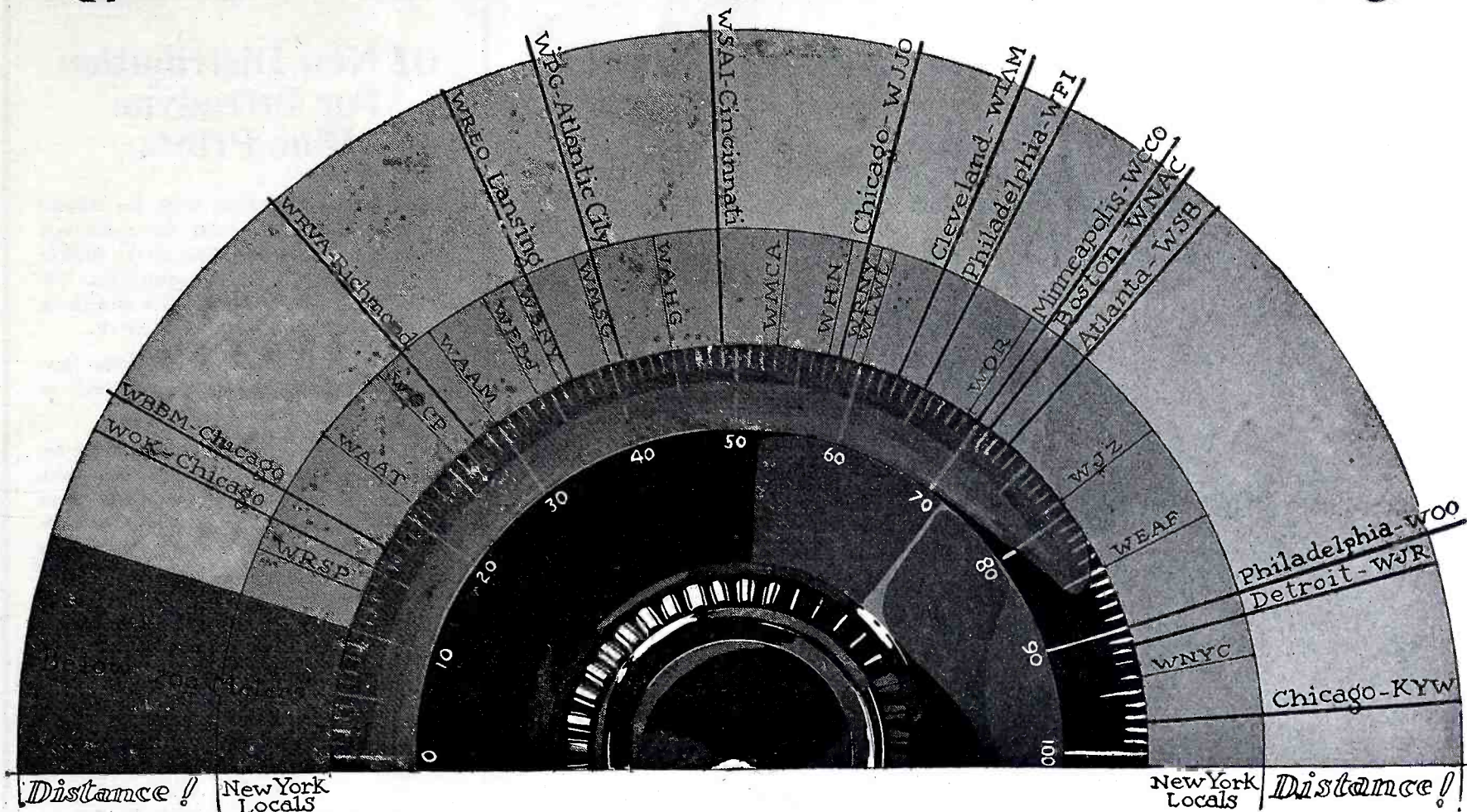

In New York City

Where confusion reigns in the air and station overlaps station on the tuning dial of the ordinary radio receiver, the R. G. S. Receiver, in a recent two hour test, brought in *sixteen local stations without "cross-talk."* But that's only the beginning of the story. The R. G. S. Receiver during the short period of this test, pierced through this heavy barrage of locals to fifteen distant stations—*still there was no trouble with "cross-talk."* The actual results of this two hour test are recorded in the log above. We claim that this is meeting modern broadcast conditions—and meeting them **CONCLUSIVELY.**

For a demonstration of this receiver, write today, giving us your name and address and the name and address of your dealer

R. G. S. RECEIVER
 GRIMES RADIO ENGINEERING COMPANY, INC.
 285 MADISON AVE., NEW YORK CITY

DEALERS: *Write for Complete Merchandising Information*

BUILT FOR MODERN **BROADCAST CONDITIONS**

Cardwell Condensers

Consider The Effect of Hard Usage!

You Can't Afford Cheap Materials In Your Set —

unless you only expect to keep the set for a month or two.

The invisible wear of the elements on a condenser is no less severe in proportion than the terrific hurricanes which rear across the seas, battering to destruction everything in their paths.

Cardwell Condensers, from the giants built for Transatlantic Telephone communication to the tiny "BALANCET" have everlasting wear built into them. *They cannot wear out.*

For Broadcast or Short Wave reception, the Taper Plate Cardwell Condenser is the finest instrument made. Its Ideal Tuning Curve separates Stations perfectly. The price is within everyone's reach.

(\$4.00 to \$5.00)

Send 25c for Catalogue and Handbook

The
Allen D. Cardwell Mfg. Corp.
81 Prospect Street Brooklyn, N. Y.

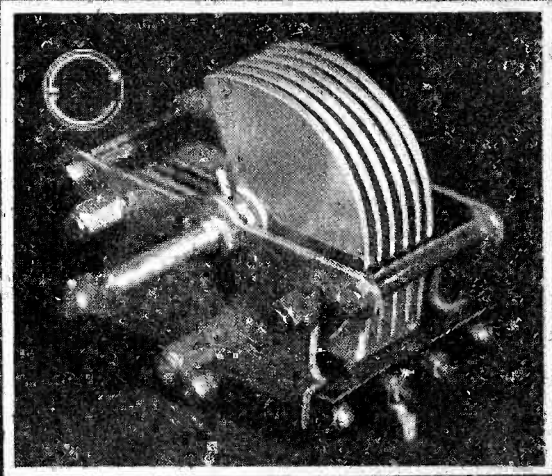

"THE STANDARD OF COMPARISON"

NOTICE

Of New Distribution For Infradyne Blue Prints

Effective November 20th, 1926, the Official Infradyne Blueprints will be exclusively distributed to the trade East of the Rockies by the Herbert H. Frost organization. Distribution to radio dealers will be made from any of the Frost offices listed below.

Delivery will be made on and after November 26th. Stocks of blueprints will be carried at each Frost office.

Radio dealers are invited to write now for trade prices. The new blueprints have been prepared by L. C. Rayment and have been revised and corrected as of November 20th. There will be no changes in the blueprints for at least six months, thus affording full protection to the dealer and set builder.

Herbert H. Frost, Inc.

160 North La Salle St., Chicago, Ill.

P. A. KILEY

30 Church St., New York, N. Y.

B. B. DOWNS & SON

2360 University Ave.
St. Paul, Minn.

M. A. WETMORE

1324 Hibernian Bank Bldg.
New Orleans, La.

H. B. PARK

305 Seventh Ave., Pittsburgh, Pa.

CAMPBELL & KNIBB

Colorado Bldg., Room 520
Washington, D. C.

EAMES CORPORATION

10 High St., Boston, Mass.

S. J. HUTCHINSON JR.

Bourse Bldg., Philadelphia, Pa.

— BEAUTIFUL —

Consoles for the INFRADYNE

—Constructed of solid walnut with burl redwood overlay decoration and finished in a beautiful hand rubbed lacquer finish. Will take any radio

panel up to 8x30 inches, including the Infradyne.

—Price: \$90.00 list, f.o.b. Los Angeles, California.

Send for Catalog of Other Radio Furniture

A-1 Woodworking Company

1332-1342 San Julian Street

Los Angeles, Calif.



{ No. 580 Console }

LET US BRING YOUR



UP-TO-DATE!

WE specialize on the DeLuxe Model of the Sargent Rayment Infradyne. This receiver is acknowledged to be the outstanding set of the 1927 season. Our own experience with the set convinces us that it is destined to lead the radio field for many years to come. In our test laboratory we have received two Japanese Stations—JOAK and JOBK; 2BL in Sydney, Australia, as well as PWX, CZE, WBZ, WEAN, WNYC, WRNY, WGY and WJZ. Selectivity is razor-edged.

We guarantee to rebuild or service any Infradyne and make it the equal of our laboratory model. We have installed special laboratory test instruments to do this. Charges are reasonable. Send in your set and when you get it back all parts will be matched. It will be tested on DISTANCE and DIALS LOGGED for direct reading in wavelength.

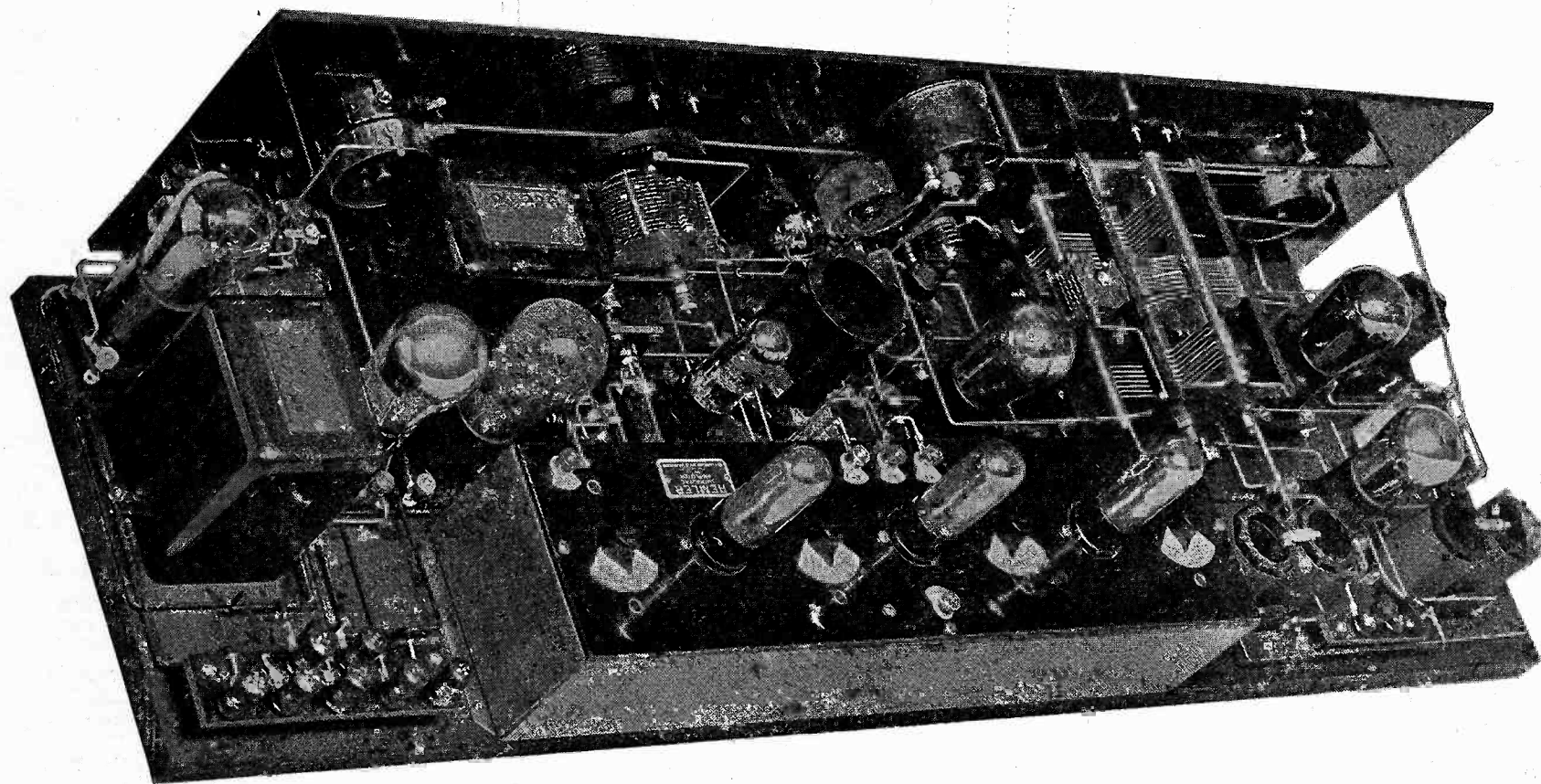

NOTE When shipping the set, remove it from the cabinet and put in heavy carton or wooden box. If shipped in a box, screw the baseboard to the inside of the box. Ship by prepaid express.

**INFRADYNE
KITS**

Containing only specified parts, each part laboratory-tested and matched to the others. Full instructions accompany each Kit. SARGENT-RAYMENT KIT, Complete

\$118.00

INFRADYNE BLUE PRINTS - \$1.00 per set, postpaid

RADIO SERVICE CO.

1202 Franklin Street

Oakland, California

THE sharp tuning and fine tone quality of the Ultimax depends largely upon this Special Ultimax Unit—due to its scientific design and the perfect balancing of inductance and capacity. Housed and sealed in compact bronze finished metal case with connections conveniently and plainly marked. Price \$5.00

THE set of 3 Special Ultimax Coils are designed specifically for the Ultimax receiver and are balanced perfectly for use with the Ultimax Special Unit. They are wound to the exact specifications of the designer. Set of 3 Coils in Carton. Price \$6.50



This Special Unit is the Heart of the ULTIMAX

THE great popularity of the Ultimax 5 tube Single Control receiver is due primarily to its ultra-selectivity and exceptional tone quality—a rare combination where congested broadcasting conditions exist.

The Ultimax Special Unit is the key to the outstanding success of this popular circuit. It has been designed to give a high degree of selectivity—equally sharp on both high and low wave lengths alike, without being critical.

The radio frequency amplification of the Ultimax is exceedingly high and uniform over the entire receiving range. This is achieved without self oscillation on the low wave lengths and without loss of energy amplification on the high wave lengths.

So popular has become this circuit, that the pioneer manufacturer of radio essentials has secured the exclusive license to manufacture the essential units of this receiver under the exact specifications of the designer and are now available in individual units or included in complete knock down kit form—containing everything but the cabinet.

To insure obtaining the desired results—make sure you obtain the genuine Ultimax foundation units as manufactured by the Pacent Electric Co., Inc., consisting of the Ultimax Special Unit and the set of 3 Special Ultimax Coils.

If your dealer hasn't as yet obtained them, he will gladly get them for you.

All the necessary parts for building the Ultimax 5 tube single control receiver—including Ultimax Special Unit; Set of 3 Special Ultimax Coils; Pacent Triple Gang, True Straight Line Frequency Condensers; Pacent Universal Cushion Sockets; Pacent Jacks; rheostats; battery switch; vernier dial; engraved and drilled panel; binding posts; necessary hardware together with blue prints and booklet—"How to Assemble the Ultimax"—are contained in a sealed Kit—Price complete (without cabinet) **\$64.40**

The booklet—"How to Assemble the Ultimax"—giving full details and a complete set of blue prints for assembly and building may be obtained from our Pacific Coast Representative (address below) at the nominal cost of **\$1.00**



PACENT *Ultimax* ESSENTIALS

VIEW BENEATH SUB-PANEL

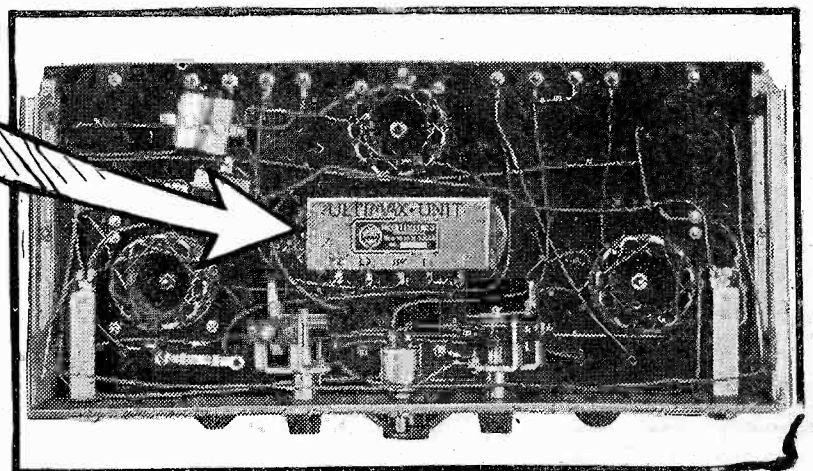

Pacific Coast Representative

JAMES P. HERMANS
585 MISSION ST., SAN FRANCISCO

PACENT ELECTRIC COMPANY, INC.
91 SEVENTH AVENUE NEW YORK CITY

WASHINGTON
BIRMINGHAM
CLEVELAND

CHICAGO
BUFFALO
BOSTON

PHILADELPHIA
PITTSBURGH
ST. LOUIS

MINNEAPOLIS
JACKSONVILLE
SAN FRANCISCO

RADIO

WITH WHICH IS INCORPORATED "RADIO JOURNAL"

VOLUME IX

MARCH, 1927

No. 3

Radiatorial Comment

As the Senate is expected to pass the compromise radio bill which has already been adopted by the House of Representatives, a summary of its salient features is here presented as the probable law of radio for many years to come. The entire industry is to be congratulated that a means has been found for eliminating past chaos and for giving authority to those responsible for maintaining order.

The New Radio Law

The regulatory power is finally vested in the Secretary of Commerce with an advisory commission and appeal board of five members. During the first year, while the present chaos is being corrected, the commission will temporarily exercise most of the power.

The commissioners are to be appointed by the President for a six year term, one man from each of the five zones into which the country is divided for administrative purposes. Each man is to be paid \$10,000 for the first year and \$30 per day of service thereafter.

The commission's first duties will be to classify and prescribe the nature of the service from radio stations, to assign station frequencies, to determine geographic location, power and time of operation, and to draft regulations to prevent interference between stations. The enforcement of the rulings as well as the issuance of licenses and designation of call letters will be done by the Department of Commerce. After the first year the rulings will also originate from the Secretary, the commission acting merely as an advisory and appeal board.

Licenses for the use, but not the ownership, of radio channels will be granted broadcast stations for three years and others for five years, with privilege of renewal. Licenses cannot be sold or transferred without the consent of the regulatory authority and they may be revoked for cause.

Government owned stations are exempt from most of these provisions and in case of war any station can be taken over by the government upon payment of just compensation to the owner. In case of mutual interference between government and private or commercial stations the former may operate during the first fifteen minutes of each hour and the latter during the last forty-five minutes, one or the other being silent in the meantime. Navy stations can send and receive press messages between points where other facilities are not available at the same rate as would be charged for similar service by private companies.

The law contains the usual requirements for secrecy as to messages heard, and prohibits the re-broadcast of programs without permission. It bans the use of profane or obscene language in all forms of radio communication. Distress signals are given priority and preference over all others. The government can exercise no other censorship.

All qualified candidates for public office are to be allowed equal opportunity in the use of any station, but no station is obliged to grant this privilege. If such political speeches

are broadcast they cannot be censored by the station. All toll broadcasting or "radiotising" must be announced as such.

A new type of radio constructor has entered the field originally occupied by the man who made his own condensers, wound his own coils, and even made the screws which held the parts together. The new man buys a kit of parts, including a drilled panel, and assembles a receiver with the aid of a soldering iron, a pair of pliers, and a screw-driver. He is a welcome addition to the fold of those who learn by doing.

The Home-Built Radio

This change in type, or rather the addition of a new type of workman, is largely due to the improvements in manufactured parts now available and also to the fact that the beginner seldom has the tools necessary for complete construction. The requirements of these assemblers are met by complete kits of parts and published instructions, such as can be seen in any radio magazine of today.

Yet this does not mean that the pioneers are any less in number or enthusiasm. For their benefit as well as for the guidance of those whose initial success in assembly has led to greater interest in handiwork, Samuel G. McMeen has written a series of articles on shop practice. These embody the results of his own experience as an amateur mechanic. For while practicing his profession as a telephone engineer he enjoyed the hobby of making useful things with his hands. Consequently his ideas on amateur-shop-ways-of-doing-things, as published in these columns, will be found as useful as they are interesting.

Statistics show that nearly half a million home-made radio receivers were built last year. While this is only about one-fifth the number of factory-built sets sold during the same period, it represents a considerable increase over each preceding year. The number of people who want to hear radio is undoubtedly increasing at a much faster rate than is the number who want to build radios, but the latter is steadily growing.

The amateur set builder virtually runs a testing laboratory for the manufacturers of factory-built models. He tries out the new apparatus that is constantly being made, adopting it if good and discarding it if poor. Meanwhile the manufacturer, watching the results secured by the amateur, is able to incorporate the approved equipment in his own product without assuming the expense of costly mistakes in adopting duds.

Consequently the home-built set is usually several months in advance of the factory-built radio. Many an amateur set builder buys a manufactured set for his family use on the basis of his own experience with that type of circuit. But he is always tinkering with another pet which is just one jump ahead of the family music-vendor.

How Amateur Radio Scooped

A Thrilling Narrative of Success in Reporting the Catalina Swimming Contest

By Don C. Wallace, nu6AM

AT the crack of the gun which started 102 swimmers in the famous Wrigley marathon swim at Catalina Island, it was amateur radio which first carried the news. The information on the arrangement of the starters had already been sent. So when that small batch of code "11.21" was transmitted from the Associated Press tug *John H. Stewart*, all of the newspapers in the United States knew about it within a minute. From then on, it was the trained news gathering force of the Los Angeles A. P. bureau who kept the air hot with the first news about the progress of the swim.

A short wave 50-watt set was placed aboard the A. P. boat by Bill Briare, with the some time assistance of 6BOL and 6DDO. The entire job was supervised by Fred L. Dewey, district manager of the Los Angeles district of the Federal Telegraph Company. Mr. Dewey is an ardent amateur in his spare time, as are many of the commercial operators of today. It is that pep, ginger, and stick-to-it attitude of the amateur at his hobby that brings results. Con-

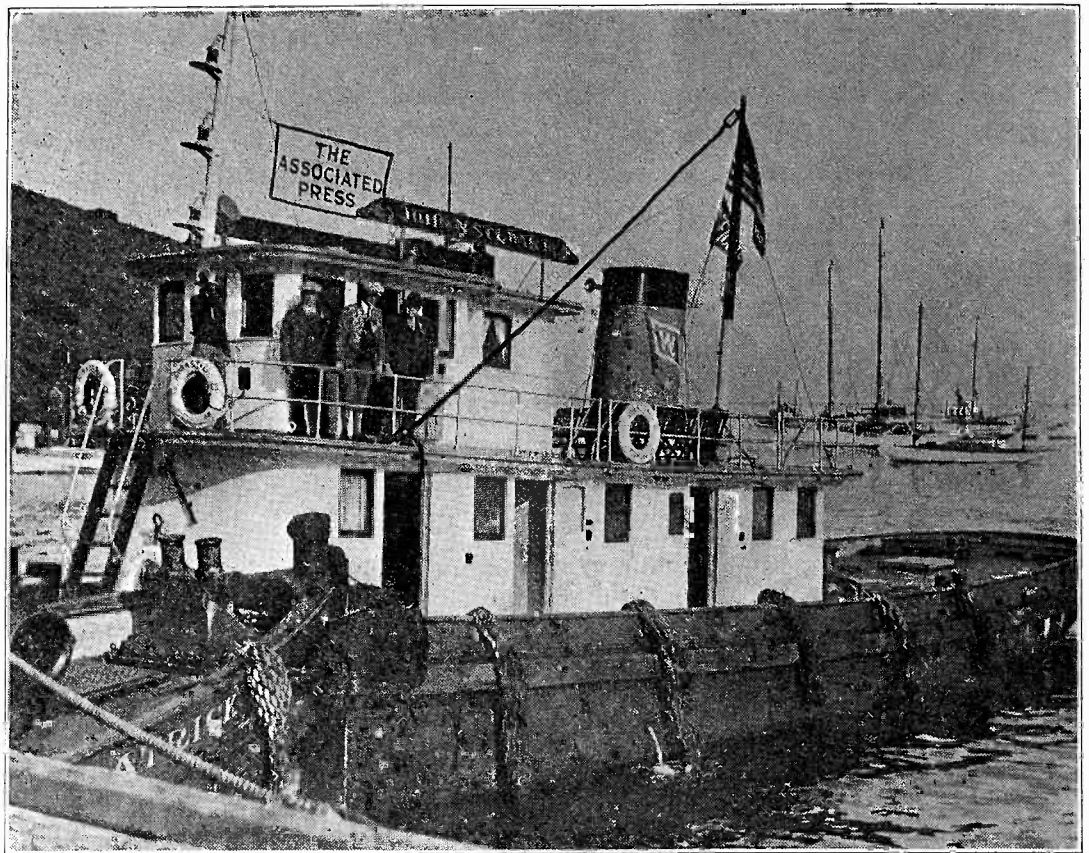

The News Transmitting Station

sequently in Mr. Dewey is found the man responsible for the idea that amateurs could beat all other services at a

time when the air would be swamped with commercial wave transmissions, everybody trying to clear their stuff at once, and practically everyone trying to clear through the same station. This clearly meant calling and answering, taking turns, with resultant delays of from 1 minute to several hours. In the eyes of the A. P., the minute they can beat the opposition is worth hours.

Radio station 6AM owned by the writer, was chosen as the shore station. It was far away from the commercial stations, and yet right on the ocean where direct wire telephone communication could be had with the A. P. headquarters on the dock at Wilmington. With the mercury arc plate supply (described in October, 1926 RADIO), and plenty of power, conditions on the shore were well nigh perfect. 6AM is equipped for rapid change from 19 to 39 to 79 meters and as the 80 meter band would have to be used at night for so short a distance, it was also used in the daytime, both at 6AM and aboard the *John H. Stewart*, call letters KGBJ.

To pull such a stunt it was also necessary to have a crack receiving operator. So the Federal Telegraph Company furnished Lindley Winser (who in his spare time is 6OU). Mr. Winser, together with the writer, maintained a continual watch for over 22 hours.

This would have been simple had that tug been on dry land. Instead, it was in the midst of one of the roughest parts of the coast, and from reports



The News Receiving Station

aboard, some considerable portion of the trip was spent alongside the customary rail. That the ship looped the loop was clearly evident from the manner in which the 50-watter's wave soared and swung, returning upon itself—sometimes.

This made it necessary that the receiving set be operated in a non-oscillating condition where it would be broad enough to ignore most of these frequency changes. This would not have been possible except for the fact that the old 9ZT receiving system (extremely long antenna) had been transported to the present 6AM, and consequently was doing its stuff. Those hams who were unfortunate enough to tune into the KGBJ signals still have the "willies," we understand. So probably we can consider the transmissions from the A. P. boat, not only speedy and accurate, but also secret, as far as the general public, or even hamdom, is concerned. This of course could have been corrected to a degree if ample time had been taken before the race, but practically the entire arrangements were made within 48 hours prior thereto, a fact which adds to the credit due Mr. Dewey and "Bill."

The bulletins and flashes came in at frequent intervals from the start to the finish. None of these messages rested in the radio shack of the tug, for as soon as an A. P. man dashed into the radio room, away would go the message, without so much as a call. Winsor was always on the job, and when it was all done, back would come the snappy rr k.

In the radio room of 6AM, Winsor ran the mill most of the time, with the writer at the key, checking swimmers' names and numbers, copying all the while, looking over Winsor's head to fill in during the worst loop the loop stunts of the tug. With two men thus on the job, almost no fills were required, and these fortunately never came during an urgent message. As the mill pushed out the sheet it fell into the hands of the special representative of the Associated Press at the station, who phoned it to the clearing house, at the Wilmington dock.

Some of the typical bulletins were as follows: "Toth, 92, was a late starter. Delayed by greasing, he struck out from the Santa Catalina shore sixteen minutes after the gun had sent the others on their way . . . As the afternoon waned the sea panorama revealed an open expanse of water, with occasional heads and attending rowboats indicating swimmers still in the race. Long stretches of the channel separated these, in striking contrast to the crowded ocean of the morning following the start from the isthmus . . . Norman Ross, hailed at 11:55 p. m. by the A. P. boat and asked how he was getting along, replied 'Fine and tell 'em I'm coming in.' Ross at this time was approximately 2½

miles in the rear of Young, the leading swimmer who had approximately 2½ miles to travel to his goal . . ."

George Young was frequently interviewed as he sped on his way, our men continually reporting him in excellent condition and stroking along at a fast clip starting at 58, dropping to 52, then 48. Even after 12 hours in the water he swam at 42 strokes per minute. For nearly two hours, just off shore, he battled with the tide, which almost swept him back to sea, yet his speedy, almost joyful pep carried him through when the others couldn't make it.

As he neared the shore, KGBJ advised us to get all set for the flash of the finish. We sat on the edge of our chairs, tense, and waiting for the long dash which was to denote the arrival time. When it finally did come we shouted with joy for the 17 year old lad who showed the world such swimming as it never has seen before.

The A. P. report then continued as follows: "In Young's boat everything was joy, the young man himself, although worn out with the battle against wave and tide, was in fine spirits and felt no serious effects from the long grind. Norman Ross, his closest competitor, abandoned the swim at 2:40 a. m. This was not learned until Young had finished and the A. P. boat started back over the course to check up on any other contestants who might be still in. . . The last moments of Young's struggle were thrilling as the young Canadian cut down the distance to 250 yards from shore, to 100 and then 50. Launches and small craft gathered around him their searchlights playing over the water as flares were lit on the

beach. On the sand was an enthusiastic crowd cheering its united throat hoarse while on the highway above automobile horns were wildly blowing. As Young neared the shore he sprinted, and when an oar from the observer's boat touched bottom his handler jumped from the tender, hoisted him bodily aboard his power boat, then carried him off, but only for a few yards. Her propeller fouled in a line or some kelp. She was unable to move and shot up distress signals. The Associated Press boat went to the rescue, towed her off shore, and then turned her over to another craft that headed for San Pedro and rest for the weary swimmer."

All of the Associated Press reports were gleaned from direct observation, using no hearsay or rumors. In the meantime the broadcasting continued from 6XA, aboard the S. S. *Avalon*, and we could hear it in the broadcasting receiver coming as relayed through KNX, Hollywood. At the time of the landing of Young the *Avalon* was several miles to the rear, furnishing a very interesting broadcast of those parts of the race which came under their observation. They were unable to see the finish through the black of night (3:06 a. m.) and consequently broadcast many rumors to the effect that Young, Ross and Pete Meyer had all landed.

Pete Meyer did stay in the water nearly two hours longer than Young, but the strong currents finally proved too much for him, so he quit. The S. S. *Avalon* acted as a hospital ship for the swimmers as they were taken out, and carried over to the *Avalon*. 6XA broadcast information from these swimmers. It certainly was an exciting night on any kind of a radio receiving set.

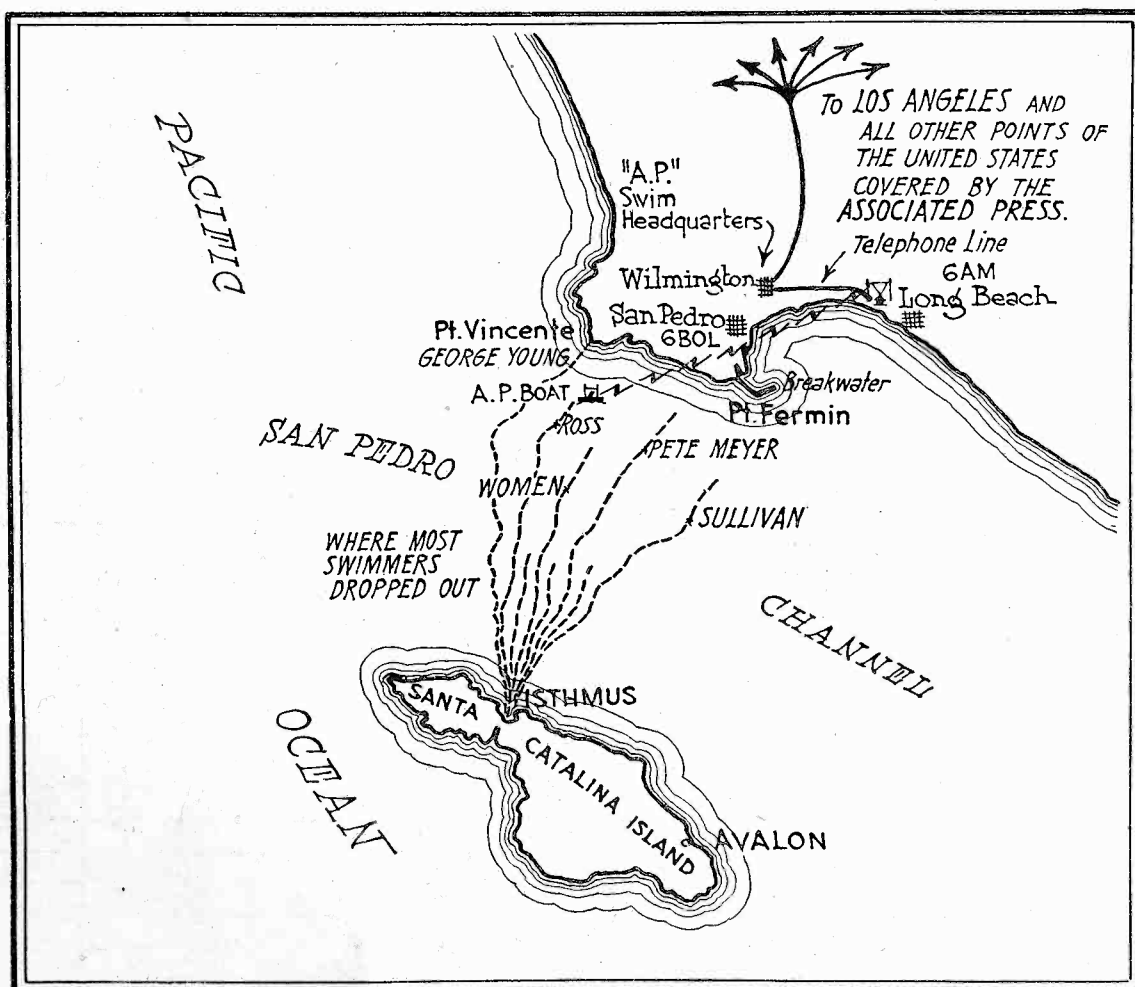

Sketch Map of Swimming Course

Infradyne Tips

Simple Changes for Controlling Volume and Oscillation, Increasing Amplification, and Operating From Battery Eliminator

By E. M. Sargent

THOSE who have built the Sargent-Rayment infradyne as described in November, 1926, RADIO may be interested in a number of slight changes that make for smoother and simpler operation. Practical experience has shown that the 50,000 ohm resistance across the grid and filament of the mixer tube is not needed unless the set is located close to local stations whose volume is too great. Its place on the panel may be taken by the baseboard rheostat, which is used to cut down the filament current in the mixer tube, thereby reducing the plate current from the constant 90 volt supply. This change is shown in Fig. 1.

If the 50,000 ohm resistance is retained it should normally be left in the "off" position, cutting it in only when necessary to reduce the volume of locals. The usual 50,000 ohm resistance surrounded by a nickel-plated shell is not suitable for this circuit, as it reduces the sensitivity and broadens the tuning. The Frost 886 unit was especially designed for this circuit, being wound with fine resistance wire on an insulating strip placed around a bakelite core.

Two-thirds of the infradyne's selectivity is due to the two r.f. stages preceding the infradyne amplifier. The set is most selective when these three circuits are in resonance, when the tendency to oscillate is also the greatest. This resonance is controlled by the two trimmer condensers on the panel, which should first be set so as to give maximum oscillation. The oscillation can then be stopped by cutting in more plate resistance with the 200,000 ohm variable resistance marked "volume control" at the right of the panel. It may be necessary to slightly readjust the

main tuning dial after tuning the trimmers. The trimmers require less attention when used with the Cardwell three gang condenser than with some others. A third trimmer inside the set is left fixed at one-third to one-half its maximum setting.

The three trimmers are necessary because of the single dial control of the three tuning condensers. Each of these condensers is associated with an inductance coil, all three of which have the same characteristics, so that the same condenser capacity will tune them to the same wavelength. But as the total capacity of the three circuits is seldom the same, any unbalancing must be equalized by the trimmers.

Thus the capacity of the first tuned r.f. circuit varies with different antennas. The capacity of the second is affected by the length of the grid lead. That of the third by the grid condenser and leak. With matched coils the three circuits should stay in line after the trimmers have once been adjusted.

Failure to stay in line, which is indicated by having to re-set the trimmers for different wavelengths, means that the three sections of the triple variable condenser do not change equally in capacity. A slight readjustment of a good type of condenser will often correct this unbalancing so that the trimmers need not be touched. Some condensers cannot be changed and reliance must be placed on the trimmers.

When a condenser is set for maximum capacity the rotor plates should be exactly half way between the stator plates when looked at through a piece of white paper. If they are closer to one side than the other an experienced radio builder can correct the trouble by

loosening the nuts that hold the stator in place and sliding the stator around until its plates are in the right position. Never try to bend the plates.

Smoother operation and increased amplification may often be obtained by using 67½ instead of 90 volts on the plates of the small tubes while retaining 90 volts on the large tubes. This may be done by changing one connection in the set, as shown in Fig. 1. In the set described in November RADIO, the change is made by first removing the joiner wire between that leading to the 90 volt binding post and that tapped off the wire (below the 1 mfd. condenser), joining No. 6 on the oscillator coil and the B post of the infradyne amplifier. Then run a wire from No. 6 to terminal B on the first audio transformer. This puts the B supply for the 99 tubes on the 45 volt binding post, which should be connected to the 67½ volt + B battery clip. This also supplies 67½ volts to the two detectors which will operate as well on 67½ as on 45 volts.

The critical adjustment of the rheostat on the first detector tube may be eliminated by putting a .001 mfd condenser and choke coil in the plate circuit

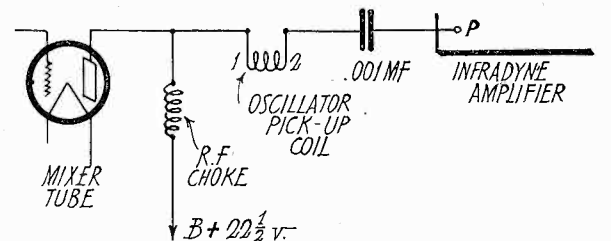

Fig. 2. Alternative Method of Plate Supply to First Detector.

of the tube, as is shown in Fig. 2. The choke may be either a Remler No. 35, Bremer-Tully, or Silver Marshall No. 275. This requires an extra B battery

(Continued on page 60)

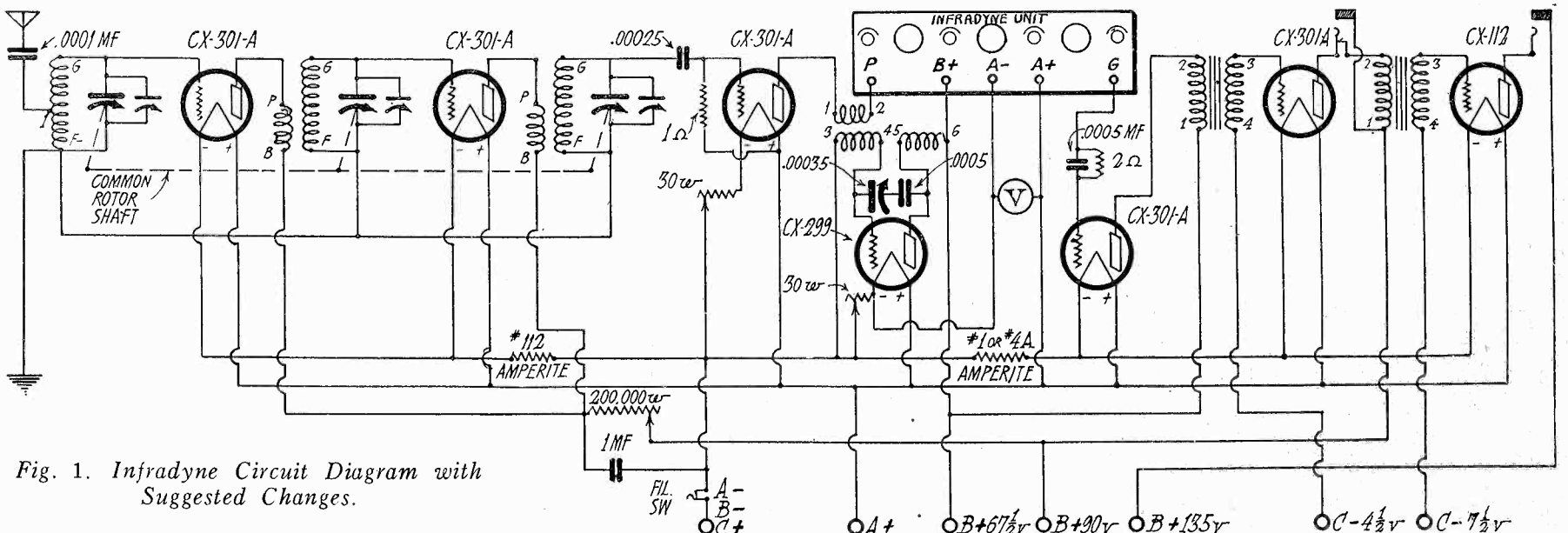

Fig. 1. Infradyne Circuit Diagram with Suggested Changes.

What Price Tone Quality?

Improvements in Broadcast Transmitters Whereby the Complete Audio Scale May be Heard

By S. R. Winters

THE great improvement in tone quality since the Western Electric Company sold its first broadcast transmitter to the *Detroit News* five years ago has been made possible by patient research work in the Bell Telephone Laboratories. Today the audio output of a modern station covers a greater range of frequencies than the average set is able to receive efficiently. Of the several factors that have contributed to this result the most important is the audio input transformer.

The prototype of the modern audio transformer was the repeating coil which telephone engineers used to more efficiently connect two circuits of different impedances. Thus in connecting a subscriber's line to a trunk line of different impedance, some of the energy would be reflected back and lost unless their impedances were matched by means of a repeating coil. Prior to the advent of radio broadcasting there was no occasion for extending the audio frequency range above 2300 cycles or below 135 cycles.

Even as recently as 1923, broadcasting was confined to less than three octaves of the musical scale. The

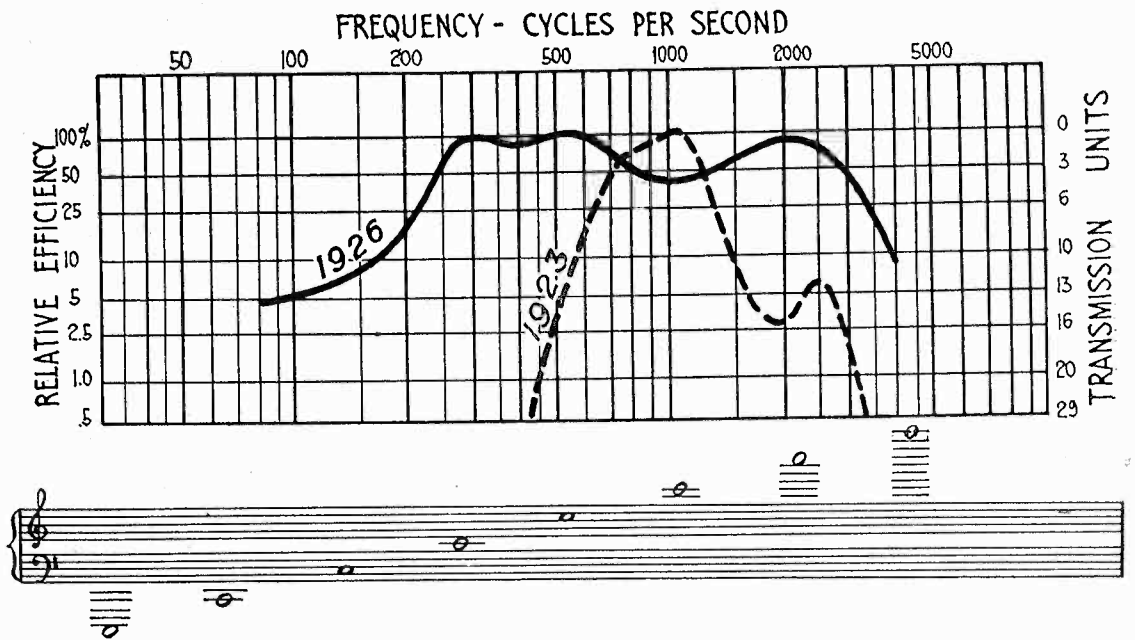

Comparison of Transmitted Audio Frequencies.

listener blamed his receiver for this limitation, whereas he now gives full credit for the reproduction of high and low musical notes to his radio receiver and loud speaker.

In reality, however, it was not until after research engineers of the Bell Telephone Laboratories had developed input transformers capable of passing the

higher and lower audio frequencies with equal amplification that the broadcast transmitters gave the full tone values of music. These improvements have involved the use of permalloy as core material and special windings of very fine insulated wire.

Such transformers are found not only in the broadcast transmitter itself, but

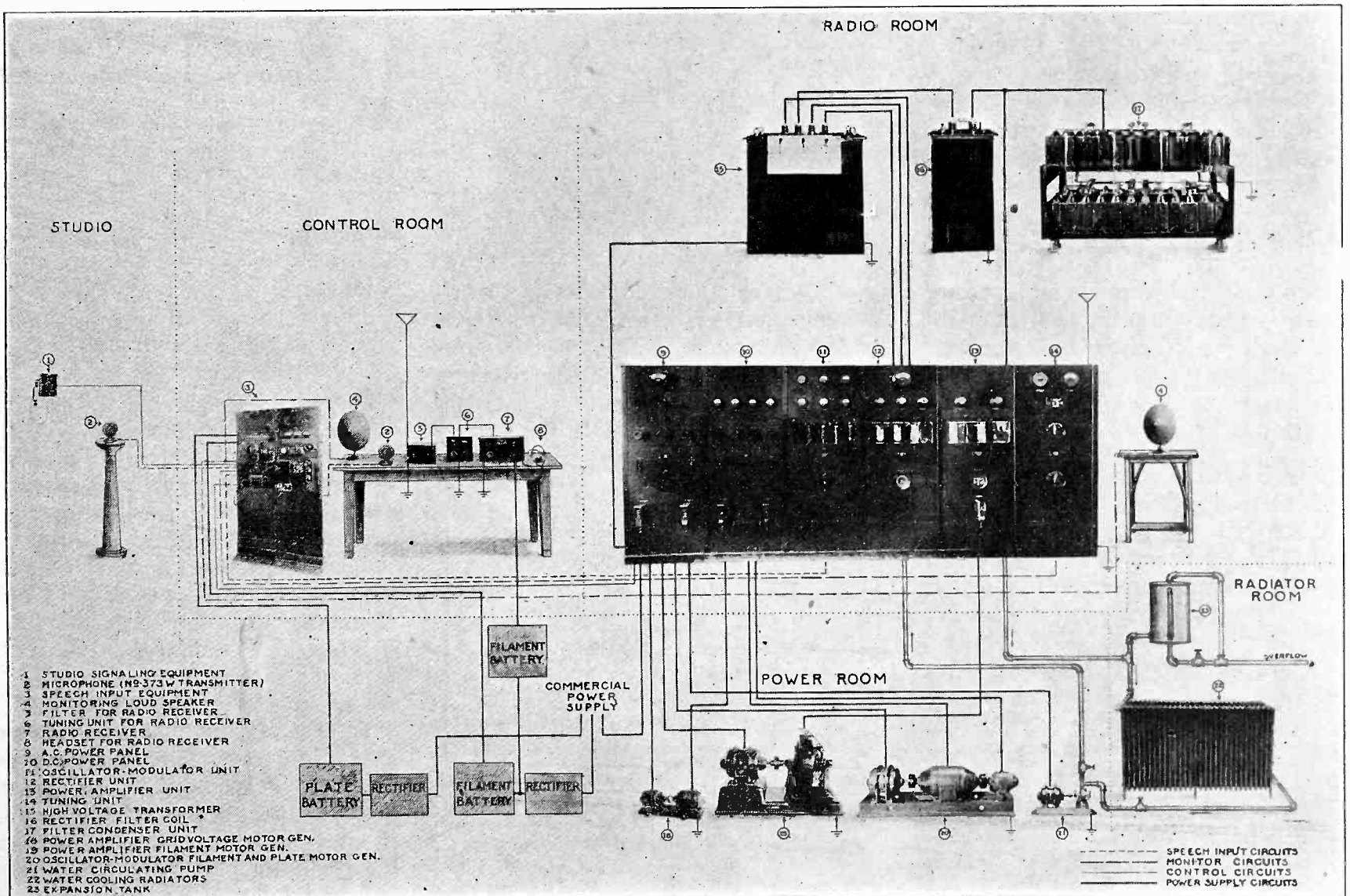

Western Electric 5 K. W. Broadcasting Equipment.

also in the audio input amplifier at the studio, in the repeaters at intermediate points in a wire network, and in the input amplifier at the station. The development of accurate testing circuits has been an essential feature in the evolution of the modern high grade transformer.

Coincident with improvements in audio transformers, many other factors have contributed to the overall performance of broadcast stations. This progress has been made through the use of higher power, making transmission more reliable, methods of stabilizing the frequency of the carrier wave, giving better quality of reception at certain points, and less noise from spurious currents in the transmitting circuits.

A Socket Power Oscillator

By Boris S. Naimark

A SIMPLE and inexpensive portable oscillator requiring no transformer or buzzer and working directly from the 110 volt a.c. light socket has been developed by Allan T. Hanscom of Woonsocket, R. I. It has a reliable range of 50 ft. and is useful in testing, measuring and calibrating.

From the circuit diagram of Fig. 1 it is seen that filament current for an A tube is supplied through a resistance R (a 25 watt lamp for 110 volts and a 50 watt lamp for 220 volts, either a.c. or

is used, the former being more satisfactory.

The circuit may be connected as shown in Fig. 1. The general arrangement of parts appears in Fig. 2. The number of turns in the coils depends upon the frequencies to be covered and upon the maximum and minimum capacities of the tuning condenser. To cover the broadcast range the coils require the

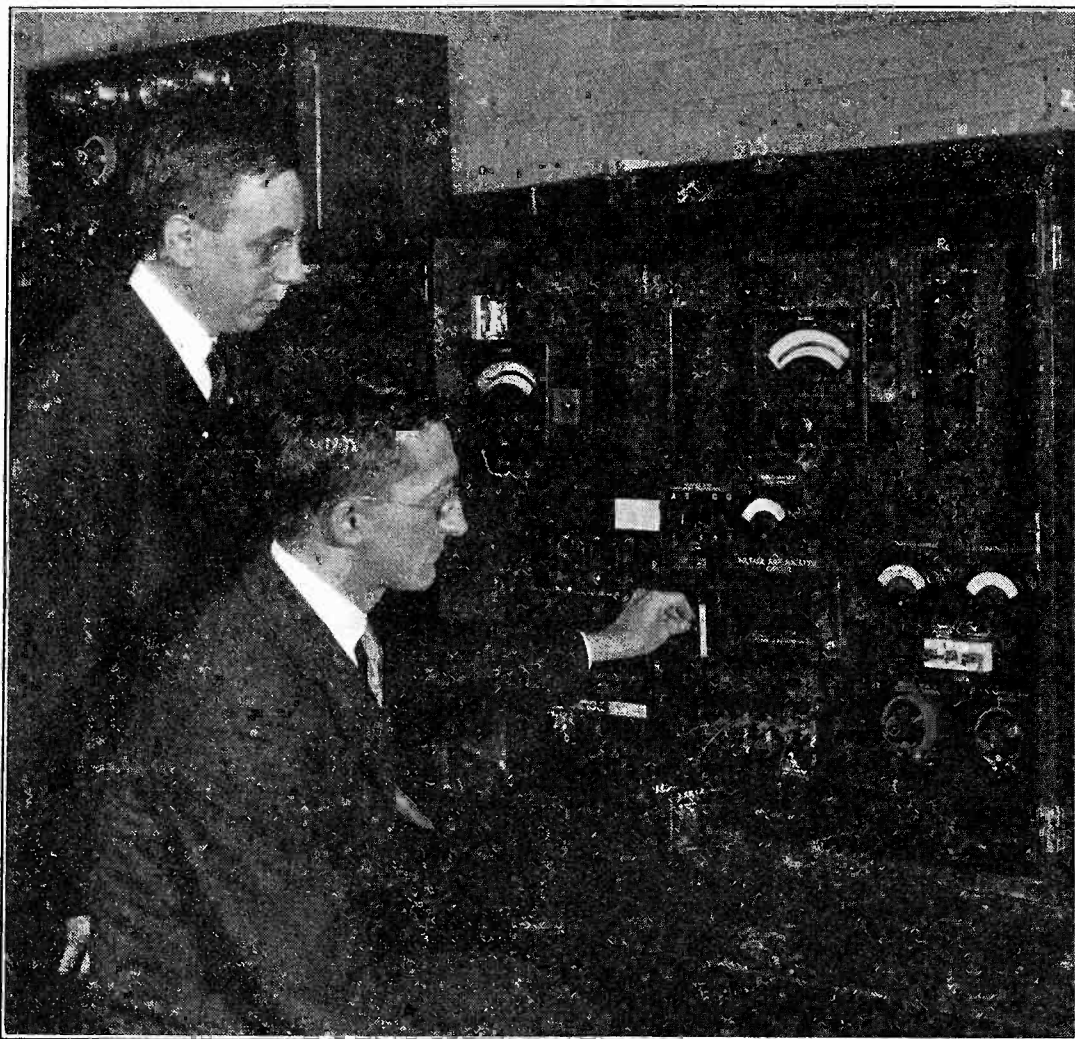

Measuring Input Transformer Characteristics.

Among other elements which may discriminate against certain frequency ranges are the microphone, the modulation choke coil, and tuned radio-frequency circuits. Each of these have been carefully studied so as to give the best possible results.

Most radio novices do not understand the abbreviations "R. F." and "A. F." which are so commonly employed. R.F. is the abbreviation for radio-frequency, which is any frequency in the radio range, *i.e.*, 10,000 to 30,000,000 cycles per second, or 10 to 30,000 kilocycles per second. A.F. signifies audio-frequency, which is any frequency in the audible range, *i.e.*, below 10,000 cycles per second. A.F. signals (sounds) can be heard by the unaided human ear; but R.F. signals must first be rectified, or "detected," by an audion (vacuum tube) or crystal detector, and then made audible by headphones or a loud speaker before they can be heard.

d.c.). The vacuum tube acts as a rectifier when a.c. is used and oscillates through the range of frequencies determined by L_1 , L_2 and C . The grid and plate returns of the oscillator are connected to opposite sides of the supply line so that the grid will be negative when the plate is positive.

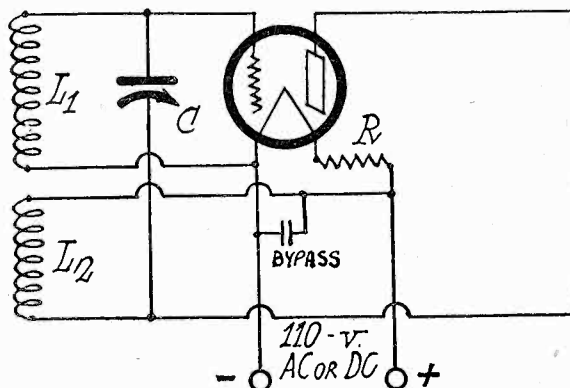

Fig. 1. Circuit Diagram of Oscillator.

Modulation is accomplished by the 60 cycle frequency if a.c. is used or the power station's generator hum if d.c.

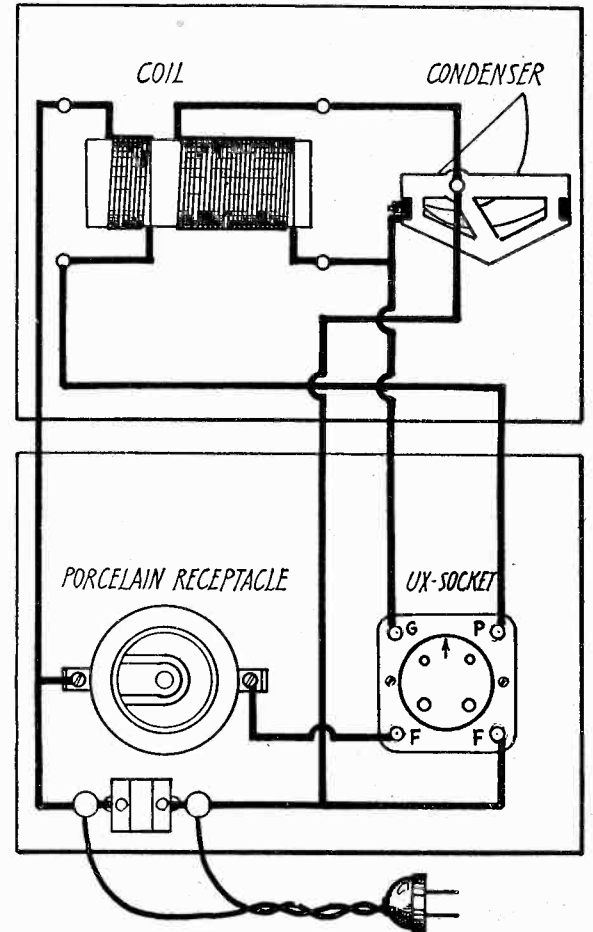

Fig. 2. Arrangement of Parts in Oscillator.

same number of turns for a given condenser as would be required for a broadcast receiver. The plate coil has the same number of turns as the grid if both are wound on the same size of tubing. The coupling between coils may be close.

The oscillator tuning dial can be roughly calibrated with a receiver. First sharply tune the receiver to a station whose wavelength and frequency is known. Then connect the oscillator to the house mains and turn its condenser dial until the 60 cycle note, as heard in the headphones or loudspeaker, reaches maximum audibility. Repeat with enough stations to cover the entire range, marking all readings on the dial or making a card record.

While this oscillator is not intended as a wavemeter, it is sufficiently accurate to determine the wavelength range of a set under test. It may also be used to calibrate short wavelengths with a short wave receiver by means of the heterodyning action of the oscillating receiver with the higher harmonics of the oscillator. It is particularly useful in neutralizing a set for various wavelengths if corresponding stations are not on the air.

The Browning-Drake Receiver

An Authoritative Statement as to How it May be Improved in Selectivity, Balance and Tone Quality

By Glenn H. Browning

SINCE the original publication of the facts about the tuned r.f. transformer which was developed by Dr. Drake and the writer as the result of mathematical and laboratory investigations at Harvard University, various people have given out considerable misinformation about the transformer and the circuit in which it is used. To correct some of these errors and to tell of some new improvements is the purpose of the present article.

The distinguishing feature of this transformer is the use of a fine-wire primary placed in a slot at the low potential end of the secondary, as shown in Fig. 1. This reduces the capacity

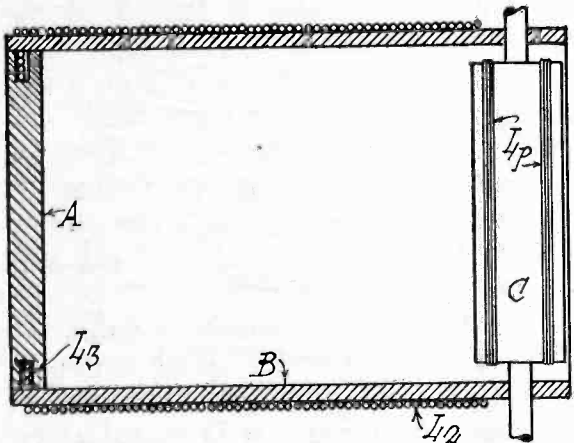

Fig. 1. Cross-Section of Browning-Drake Transformer

between the two windings and gives a transformer having marked efficiency in performance. This is incorporated in a circuit consisting of one stage of balanced r.f. amplification, regenerative detector and some form of audio amplifier. This gives a simple and effective receiver which is comparatively cheap and easy to build and selective enough to cope with the present broadcast congestion except where there are several powerful local stations within a radius of a mile or so.

Three changes in the original circuit

are recommended and are incorporated in the set here described. A midge variable .0001 mfd. condenser is placed in series with the aerial so as to adapt the set to most efficient operation with various lengths and types of antennas. An approximate adjustment may be made by setting this condenser so that the two tuning dials will have about the same reading for a 300 meter station.

The new method of balancing, as shown in the circuit diagram of Fig. 2, has been found to be better than the one formerly used. If a receiver is now balanced for a short wavelength it will also be in balance for a long wavelength. As the rotor plates of the first tuning condenser are not at ground potential, an insulating shaft in the condenser is necessary to prevent body capacity.

The audio amplifier is a combination of impedance and resistance coupling, which preserves the inherent tone quality and works satisfactorily with a B battery substitute. R. F. currents are kept out by a choke incorporated in the Impedaformer marked "first stage." Any r.f. current which may pass through the choke is by-passed by condenser C₆ between the plate and the negative filament of the first audio tube.

The condensers are placed 8 in. apart with the radio frequency tube between

them and the detector tube at the right of the r.f. transformer. This makes the important leads very short. The audio end is placed in the rear. The sub-panel is rather deep, but the results justify its size. It will be noted that nothing is placed directly between the coils. Too often transformers or other metal objects are located so close to a coil that its resistance is increased several times.

Extremely efficient coils and condensers are used in the circuit. The formers are wound with enamel wire, spaced one-half its diameter—a spacing which has been found to reduce the resistance to a minimum. The condensers have characteristics which fall in between those of the straightline wavelength and frequency types. They have low losses and small minimum capacity.

To shorten the leads carrying radio frequency currents, the connection between the stator plates of the first variable condenser and the grid of the amplifier tube should run as directly as possible. This applies also to the connection between the plate of the r.f. amplifier tube and the primary of the r.f. transformer and the connection between the stator plates of the second condenser and the grid leak and condenser. These are the most important connections in the whole set.

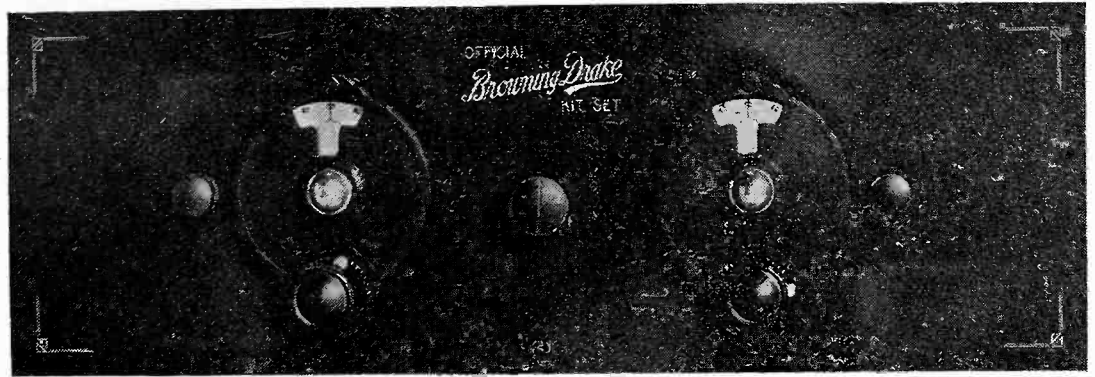

Panel View of New Browning-Drake Receiver.

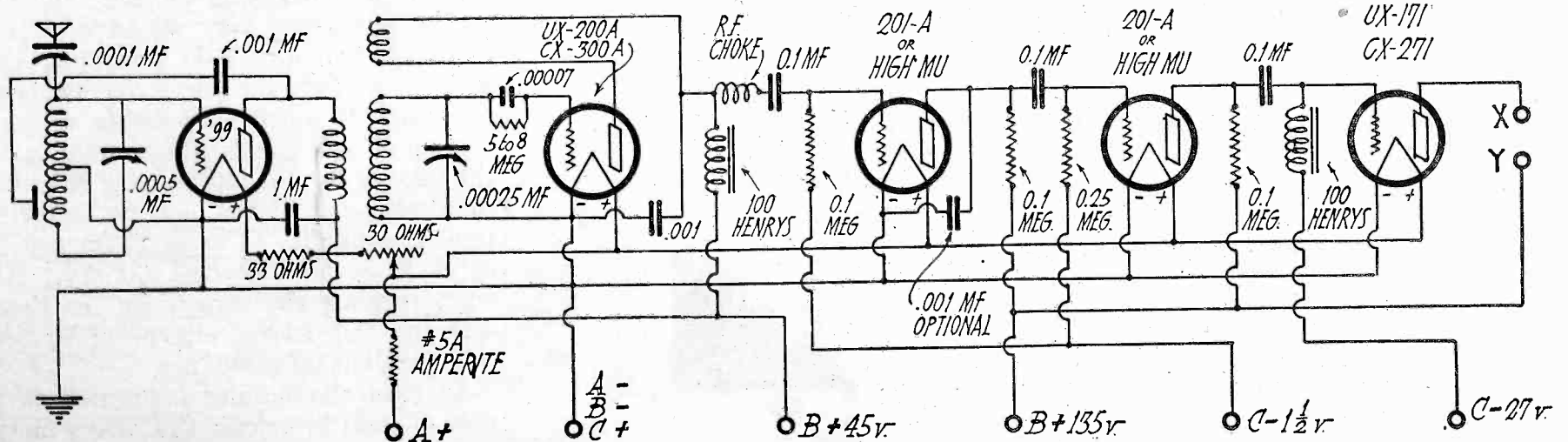

Fig. 2. Circuit Diagram for New Browning-Drake Receiver

Great care should be taken to see that the ends of the wire on the two tuning coils are engaged and well tinned. This insures good connections between the condensers and coils, which is most essential, as they carry more radio frequency current than any other connections. These should also be as direct as possible.

In wiring, it is advisable to make all high frequency connections first, installing r.f. grid and plate leads before the filaments are wired.

This receiver is intended primarily for operation with large tubes, except the amplifier where a CX 299 or a UX 199 should always be used because its small plate to grid capacity makes it easier to balance. The 33 ohms resistance in series with its filament reduces the 5 volts, which is across the filaments of the other tubes, to 3 volts. The 30 ohm rheostat then becomes solely a volume control and may be turned completely on when maximum signal strength is required.

For a detector the CX 300A or UX 200A has been chosen, as it is considerably more sensitive on weak signals than a 201A. The grid return on this tube should run to the negative side of the filament as shown in the diagrams. If the constructor desires to use a 201A as a detector, be sure to run the grid return to the positive filament (the connection from the rotor plates of the second variable condenser to the positive side of the filament of the detector tube).

For the first two stages of audio either High Mu or 201A tubes may be used. The former sometimes has a slight tendency to "steamboat" on some B eliminators. This may be remedied in a number of cases by using one High Mu and a 201A.

In the last stage of audio amplification it is essential to have some type of semi-power tube if the builder desires to deliver any amount of undistorted volume to the loud speaker. It should

LIST OF PARTS FOR OFFICIAL BROWNING-DRAKE RECEIVER

- 1 National Impedaformer (1st stage).
 - 1 National Impedaformer (3rd stage).
 - 1 .1 mfd. Tobe condenser, special type.
 - 3 .001 mfd. Tinytobe fixed condensers.
 - 1 .00007 mfd. Tinytobe fixed grid condenser.
 - 1 Yaxley filament switch and 30 ohm rheostat.
 - 8 Eby binding posts (Ant., Gnd., A+, (A-, B-) B+ Det., B+ amp., C+, C-).
 - 1 Precise Midget .0001 variable condenser.
 - 1 Browning-Drake 33 ohm. resistance cartridge.
 - 3 Resistances (.1 meg., ¼ meg., 8. meg.) Electrad.
 - 1 Browning-Drake balancing or neutralizing device.
 - 1 Amperite, type 5-1.
- Front and base panel, drilled and engraved, with sockets, resistors and soldering lugs (Browning-Drake).

be understood that signals are not made louder by the use of a semi-power tube, but more volume with good quality can be put into the loud speaker. The last tube is really the only place in the radio set where power is an important factor. The semi-power tube, such as the 171, also has an impedance which more nearly matches good cone speakers.

If it is desired to operate directly from the 60 cycle 110 volt electric light circuit, the best combination is a six-volt storage battery with a trickle charger. Any suitable B eliminator may be used.

When the set has been constructed according to the diagrams, it is ready to balance. Turning the rotor coil should give a slight "plop," whereupon touching the finger to the grid side of the radio frequency transformer—the stator plates of the second tuning condenser—the "plop" should be repeated. This is the test for oscillation in the secondary of the radio frequency transformer.

With the tickler coil set in this position, station whistles should be heard upon rotating the second condenser if any broadcast station above the noise level is operating. The receiver would then seem to be operating normally and should then be balanced so that no radiation is sent out and maximum signal strength and selectivity is obtained.

Tune in a station having a short wavelength by means of the two dials and then turn off the rheostat. Probably the station will still be audible or can be made so by adjusting the tickler coil and the second tuning condenser. Now set the balancing disc in such a position that a minimum signal is obtained. The receiver is then balanced or neutralized.

Where there are no local stations, the set may be balanced by tuning in the whistles from the semi-distant stations. Set the balancing condenser so that changing the setting of the first dial does not change the pitch of the whistle. Of course, the intensity or loudness of the whistle will always be affected by the setting of the first condenser so do not confuse this with the pitch of the whistle.

Another method of balancing when no stations are on, is to set the second dial at about 20 on the scale, turn the rotor coil until the secondary of the tuned radio frequency transformer is oscillating. This may be determined by touching the stator plates of the second condenser, when a distinct click will be heard in the speaker, if the r.f. transformer is oscillating. Now, turn back the rotor coil so that this circuit is not oscillating. Turn the first dial and determine if any setting of the first dial throws the secondary into oscillation. If it does, the balancing condenser should be adjusted until no setting of the first dial produces this result.

After the receiver has been balanced, it is ready to operate. With antenna, ground, batteries, etc., connected, set the rotor coil on the B-D transformer, in such a position that the secondary circuit is oscillating. Turn the second dial—the one to the right—until a whistle is heard; this whistle is the carrier wave of the transmitting station beating with the oscillations the set is producing, and will be heard if a station within range of the receiver is transmitting. Turn back rotor coil so that the whistle disappears and at the same time, turn the left hand dial (the first condenser) until the signals are loudest. Readjust the two tuning condensers and the rotor coil until satisfactory volume is obtained. It will be found that the rheostat makes an excellent volume control, without detuning the set.

The receiver is very selective—much more so than any B-D previously described—in fact, the selectivity has been increased as much as possible without cutting off side bands which would spoil the quality by not reproducing the high tones properly. Thus, it is necessary to tune the circuits to exact resonance in order to obtain the best quality. Always regulate the volume by the rheostat and the tickler coil—never by setting the dials off resonance.

In case the builder is located in a nest of local broadcast stations, a metal

(Continued on page 40)

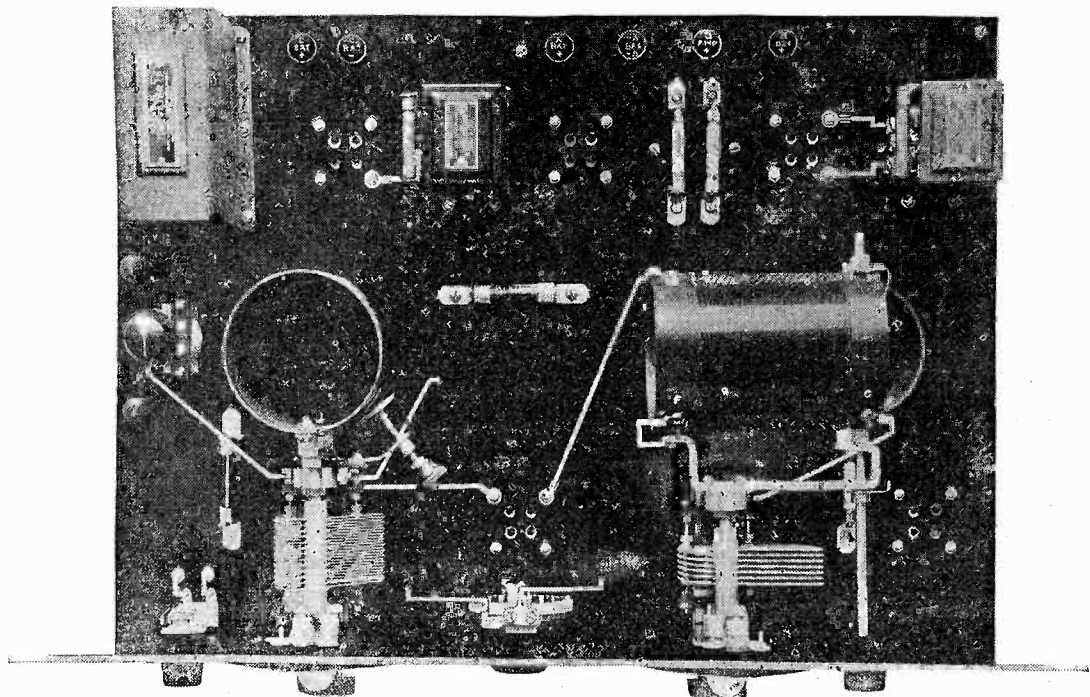

Looking Down on New Browning-Drake Receiver.

A. C. Operation of 1927 Best Superheterodyne

Directions For the Filament Re-wiring and Slight Alterations Necessary for Batteryless Operation

By G. M. Best

THE nine-tube superheterodyne described in February RADIO can be operated without batteries by using the ABC power plant described in the December, 1926, issue. The only changes in the set are to rewire the tube filaments in series and to install by-pass condensers where needed.

The circuit diagram of Fig. 1 shows eight 3-volt tube filaments in series and the ninth or power tube supplied with 6 volts a.c. A '99 tube must here be used in the first audio stage.

The eight tubes in series require 60 milliamperes at 24 volts, this being secured from the 200 volt supply by 4000 ohms of reducing resistance. This may be accomplished by means of two 10-watt mazda lamps of 1400 ohms each and two 25-watt lamps of 600 ohms each. The schematic diagram of the power plant is shown in Fig. 2.

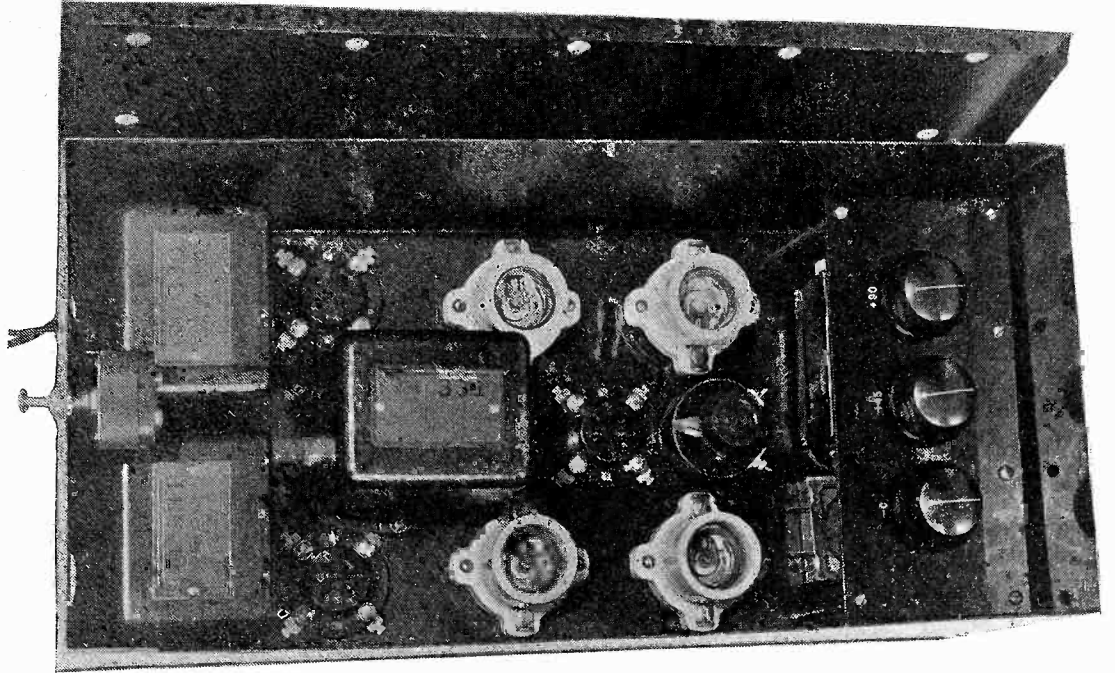

ABC Power Plant Assembly.

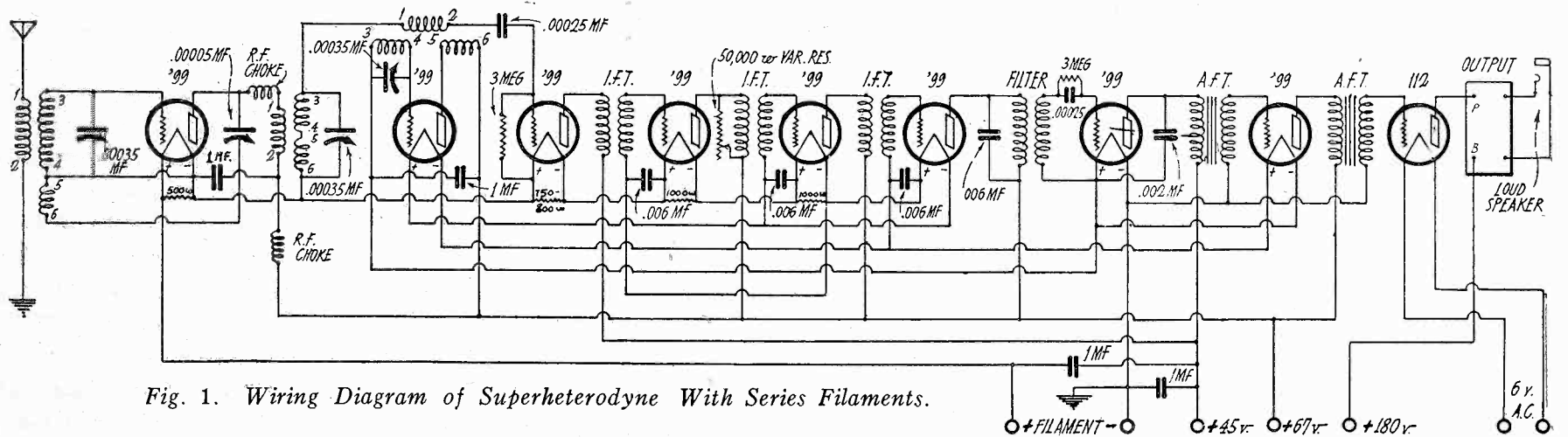

Fig. 1. Wiring Diagram of Superheterodyne With Series Filaments.

The irregular arrangement of the series filament in Fig. 1 is due to the necessity of providing the negative grid or C voltages for the various tubes from the voltage drop across the filament of some other tube in the circuit. No C battery can be used with series filament connection. The grid of the 2nd de-

detector tube, which is at the negative end of the series line, is connected through the filter transformer secondary to the positive of the filament, the detector not requiring a negative voltage.

The 1st audio tube is next connected, the polarity of each side of the filament being indicated on the diagram to facil-

itate an understanding of the connection. This tube requires 3 volts negative grid, with 67 volts plate, so that by connecting its grid return to the negative side of the 2nd detector filament, the grid is made 3 volts negative with respect to the negative end of its filament.

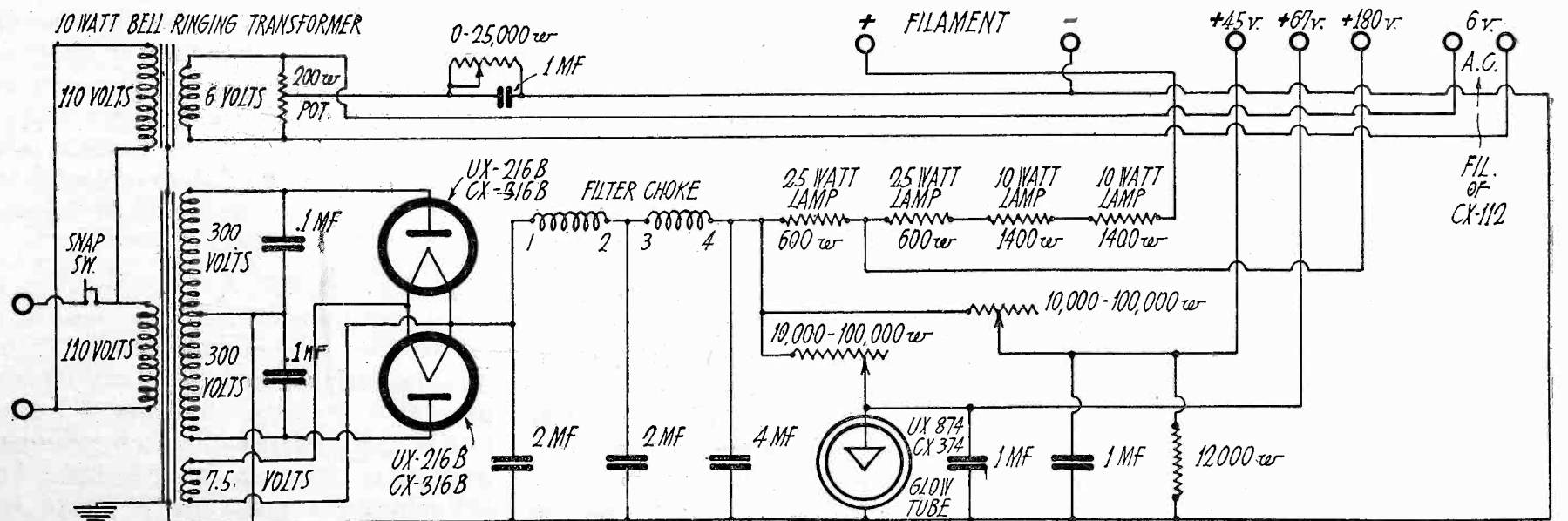

Fig. 2. ABC Power Plant For Use With Superheterodyne.

The next tube in the series line is the oscillator, so its grid return is connected to the negative end of the 1st audio tube filament to obtain 3 volts negative grid.

Next comes the 3rd intermediate tube, then the 2nd i.f., the 1st i.f., and the 1st detector, with the grid return of each intermediate tube connected to the negative end of the tube filament preceding it. The 1st detector grid return is to the positive end of its filament, so that the grid leak is connected directly between the grid and the filament. The last tube in the line is the tuned r.f. amplifier, and its grid return is to the negative end of its filament, no C voltage being provided.

As the filament current can be varied only within small limits, volume control must be obtained by shunting a 50,000 ohm variable resistance across the primary of the 2nd intermediate frequency transformer, with the slider connected to the B battery, to avoid body capacity effects. As the presence of a 50 ohm resistance, represented by the filament of a '99 tube, in series with the grid return of each i.f. amplifier tube might cause the amplifier to oscillate, a .006 mfd. fixed condenser is connected between the filament connection of each i.f. transformer and the filament of its associated tube.

To stabilize the circuit, and prevent noise of any kind from entering the set from the ABC eliminator, two 1 mfd. by-pass condensers are connected from the 45 volt B terminal in the set to the negative and positive filament circuit, respectively. These condensers are important. Without them, there may be considerable trouble from oscillation, even though there are by-pass condensers across the 45 volt tap, in the ABC power plant box.

The seven connecting wires between the power plant and the receiver should be separated into two sets, one having the minus and plus A, and the B voltage leads, and the other consisting of a twisted lamp cord for supplying 6 volts a.c. to the filament of the power tube. This is supplied from a 6 volt bell-ringing transformer in the power plant.

The C voltage for the power tube is obtained from the voltage drop in the B supply caused by the 0-25,000 variable resistance shown in Fig. 2. This resistance is adjusted until the plate current of the 112 tube is approximately 10 milliamperes, or if the 171 type tube is used, the plate current should be about 25 milliamperes. If too little resistance is used, the plate current in the power tube will be excessive, and it will soon lose its filament emission. If too much resistance is used, with consequent excessive C voltage, the plate current will be below normal, and the quality of the output, as well as the volume, will be greatly impaired.

As there are eight '99 tubes in this set, a rather disastrous burnout can occur if the filament circuit is broken while the power plant is turned on. Hence it is very important when changing tubes or testing the wiring to turn off the power plant each time before removing any of the tubes from their sockets. If the filament circuit is closed while the power plant is turned on, there will be an instantaneous surge of current through the filaments which will surely burn out several if not all of them.

If the Raytheon type BH rectifier tube is to be used for the ABC supply, certain changes in the ABC power plant must be made to accommodate the tube.

the circuit, adds itself to the total filament current in the series filament circuit, so that by the time the 2nd detector tube is reached, at the negative end of the filament line, the total current will be in excess of 70 milliamperes. Hence, a resistance shunt must be employed across those tubes which receive this excess current, to bypass sufficient current to reduce the total amount in the filament to a value below 65 milliamperes.

These resistances are shown in the diagram, and may be made up from single resistance units placed in series or parallel, according to the resistance value wanted. The 500 ohm resistance

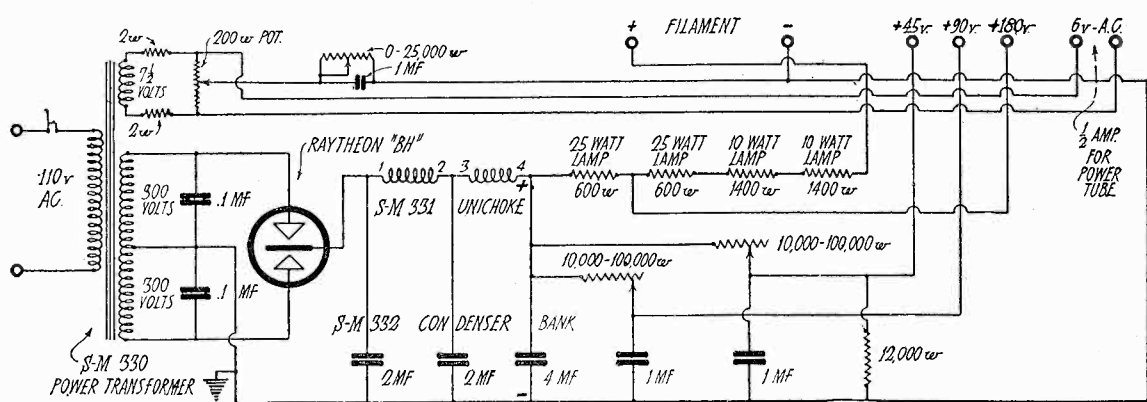

Fig. 3. Circuit of ABC Power Plant with Raytheon Rectifier.

The circuit diagram for the BH tube is shown in Fig. 3, the output terminals being identical in voltage to those of Fig. 2, so that the circuit can be used in conjunction with the receiving set circuit of Fig. 1, to make a complete receiver-power plant.

As the Raytheon tube is rated at 85 milliamperes maximum, for long life, it will be necessary to eliminate the glow tube used in Fig. 2 to regulate the voltage in the 90 volt B supply lead. This tube draws about 10 milliamperes, and while it is a useful adjunct to the outfit, it can be left out without seriously affecting the operation of the set. The glow tube compensates for changes in line voltage due to fluctuations in the power supply, and prevents sudden changes in volume in the receiving set when the filament or plate voltages rise or fall, as the case may be.

The drain on the Raytheon tube, to keep within the limits of the 85 milliamperes maximum, must be divided as follows: filament series circuits for the eight type 99 tubes, 60 milliamperes; type 112 power tube plate supply, 10 milliamperes; type 99 tube plate supply, 15 milliamperes. If the type 171 power tube is used, with its plate current of 25 milliamperes at 180 volts, the total current drain on the rectifier tube will be 100 milliamperes. Undoubtedly the rectifier tube will deliver this amount for a considerable period of time, but in the interest of tube economy, the rated maximum should not be exceeded.

The plate current of each type 99 tube, starting from the positive end of

can be made up of two 1000 ohm Carter resistances in parallel, or a 400 and a 100 ohm resistance in series. The 800 ohm resistance can be two 400 ohm resistances in series, or any other suitable combination. These resistance values are not critical and may be plus or minus 10% without affecting the results.

In setting up a circuit such as in Fig. 1, the best procedure is to place a milliammeter in the positive A supply next to the receiver positive A terminal, and adjust the filament current, with the B voltage taps disconnected, until the total is about 55 milliamperes. Then connect the B voltage leads, and place the milliammeter in the various B taps until the plate current is approximately 3 milliamperes in the 45 volt lead, and 10 milliamperes in the 67 volt lead. The milliammeter should next be placed in the negative A lead, and the total current should be between 68 and 70 milliamperes. If less than this amount, the additional load due to the plate current has lowered the filament current supply, and a lower resistance mazda lamp should be inserted in place of one of the lamps in the power plant, to increase the filament current.

As the 7 1/2 volt filament winding of the power transformer is not needed in the rectifier tube circuit, in Fig. 3, this winding can be used to supply 1/2 ampere at 5 volts by inserting a 2 ohm Carter fixed resistance in each secondary lead, as is shown in the diagram. The bell ringing transformer is hence not required.

The Amplified God

By B. W. Wilson

"GREAT Caesar's ghost! Wouldn't that wilt the gizzard of a flea-bitten prairie dog!"

This remark was made somewhere in the south end of Mexico in the middle of a sagebrush desert. We—Bill Simons and I, with our Mexican packer, Juan, our pack-ass, Juanita, and our parrot mascot, Captain Flint—we were on one of our extended rambling trips through the old Aztec country. What occasioned the remark was the sudden discovery that our remaining provisions consisted of only three cans of beans, one can of soup, and a half pound of bacon.

Bill, being inventive, made the remark. The rest of us were so astounded by the catastrophe that we just sat there and stared at the four cans and hunk of hog meat. Juanita waggled one ear mournfully; and after a minute Juan, who is not very strong in his head, chuckled.

"No mucho eats," he grinned amusedly.

"No, you greasy skinned, pot-bellied hombre!" shouted Bill wrathfully. "And

blankets were stowed away, and on top of the whole mess went Bill's radio set. It was a good set—I'll say that for it. We had picked up a lot of good stuff with it before we hit that dry, static-infested end of the country. Bill, being a former ham, had a lot of other radio junk along with him: old condensers, bulbs, grid leaks—but that comes later.

After we had the entire assortment stowed, and the pack cinched under Juanita's little fat belly, Bill pointed toward the mountains which formed a blue rim along the east, and we set off silently. For a while we journeyed in silence, and then I got curious.

"Bill," I remarked, very casual like, "where are we going?"

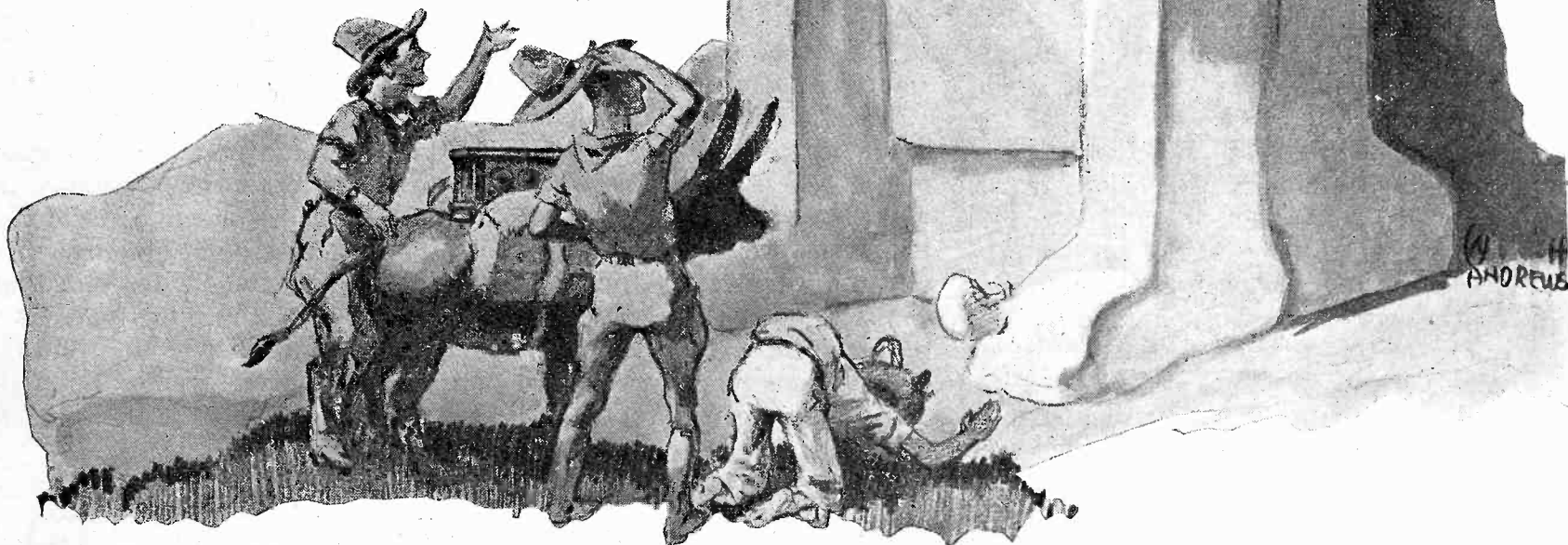

"Facing us was the most hideous image I ever have seen."

whose fault is it—you gibbering idiot? Aren't you the cook? Why didn't you tell us that the provisions were almost gone? You ought to be left out in this Godforsaken hole to starve!"

Juan gave a deprecating wave of his hand at this point.

"We eat 'um all up," he explained complacently.

"Great floppin' tripe! Of course we ate it all up. But why in thunder didn't you tell us the grub was low?"

"No mucho eats," maintained Juan stubbornly.

"We're the doggoned fools for ever trusting our food to such a heathen varmint," Bill grunted disgustedly.

Carefully he gathered up the beans, soup, and bacon and put them in Juanita's pack. Next our tent and

"Go get supplies, you donkey," he snapped peevishly.

"Uh-huh," I murmured soothingly. You have to handle Bill carefully when he is in that mood. "And where are we going to get supplies?"

"I really don't know, Al," he confessed. "But there's probably a town or something over there in those mountains. It's a cinch that nobody is going to live out on this desert by choice."

"That's the truth," I admitted fervently, and Bill winced. I hadn't wanted to take the trip in the first place, but Bill had insisted. Suddenly another thought struck me. "How are we going to get supplies after we find them? An El Paso check won't be taken, and we're not lugging any bullion with us."

"Don't worry," Bill said darkly.

"When we find a place to get food, we'll get it. Besides, something is bound to turn up. Neither of us is rich, and we've rambled all over the south end of North America without starving yet. Don't get worried, Al."

Bill is naturally of an optimistic disposition, and so he began whistling as he stalked along beside Juanita's head. Juan and I trailed meekly in their dust, dodging the cactus and rattlers when absolutely necessary. At noon we stopped for lunch—one can of beans.

"Juan," Bill said coldly, "you got us into this mess, so you don't get anything to eat."

Juan set up a howl.

"You will make un murder of me! I will die in thees hot place with nothing to eat!"

(Continued on page 42)

How to Build The R. G. S. Inverse Duplex

A Selective Tuned R. F. Receiver Wherein Four Tubes Do the Work of Six

By David Grimes

THE new inverse duplex system, whose principles were described in December and January RADIO is known as the R.G.S. to distinguish it from the original inverse duplex models. It is extremely selective and sensitive throughout the entire broadcast range of wavelengths, thus meeting the new requirements that have recently arisen. It has fine tone quality and with but four tubes it is economical in construction and operation.

As previously explained, two stages of tuned r.f., detector, and three stages of a.f. are obtained with four tubes by a carefully designed system of reflexing. From previous information it was possible to assemble the set by building individual parts or trying out those available on the market. This article tells how to build the set from standard parts which have been tested as to their suitability for the various functions that they are called upon to perform.

In the model illustrated and described no shielding is necessary because of the inherent selectivity of the circuits. But this requires the precaution of connecting the secondary of the first audio transformer directly to the grid of the first audio tube and not through the r.f. tuning circuit. Furthermore an r.f. choke of high inductance and low self-capacity must be inserted in the grid circuit to prevent r.f. current from passing through the audio amplifiers.

The reference numbers in the list of parts correspond to those in the schematic and pictorial wiring diagrams.

It will be noted that the antenna sys-

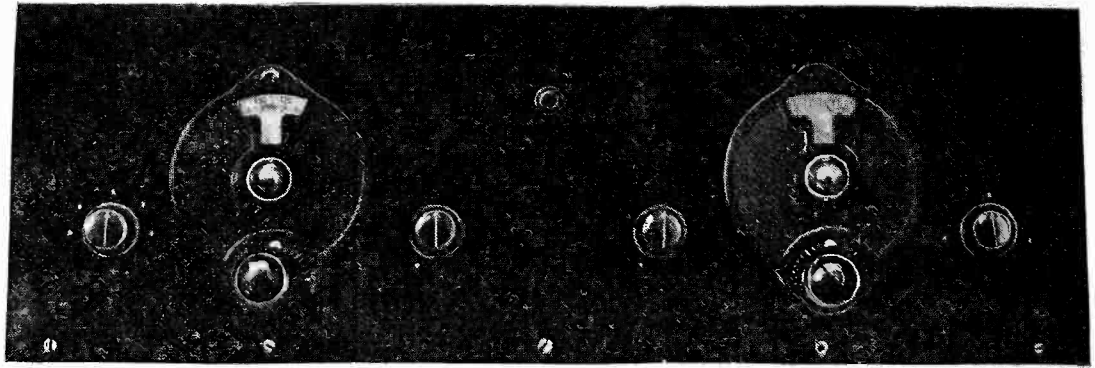

Panel View of R. G. S. Inverse Duplex.

tem (12) and the grid circuit tuner (10) are assembled as one unit which is mounted on the panel so that the shaft of the tapped inductance switch projects through the center hole of the antenna position on the extreme left of the panel. The shaft should be turned in a counter clockwise direction as far as it will go and set so that the switch lever is on the first switch point. The knob should be mounted on the shaft so that its arrow points to the No. 1 position. The .00025 mfd. by-pass condenser (11) is mounted on the frame of the variable condenser (10).

The other tuning unit, consisting of the tuning elements for the second radio frequency stage and the detector, is also made up as one complete unit. This consists of two variable condensers (2) and (14) ganged together and two tuned r.f. transformer (1) and (13). The antenna coupler and tuned transformer connections in this receiver are very important since the action of the circuit largely depends upon the proper phase angle relationships between the circuits controlled by these connections.

The midget condenser (2a) serves as an auxiliary tuning condenser for the detector stage tuning condenser (2).

By-pass fixed condensers (6), (15), (16) and (17) are mounted as shown, with (16) and (17) mounted on the frame of condenser (14).

Sockets numbers (9), (18), (4) and (30) are the first radio and second audio; second radio and first audio; detector; power tube respectively. The CX 300A detector tube should be inserted into socket (4); the power tube, CX 371 should be in socket (30); CX 301A tubes should be used in sockets (9) and (18).

The audio transformers (7) and (31) have a rising frequency characteristic, giving extra amplification on the high notes, so as to balance the effect of the fixed condensers which are connected across their windings to by-pass the r.f. currents. Thus equal amplification of high and low tones is secured. The impedance of the windings in the transformers specified are well suited to the impedances of the tubes with which they are used.

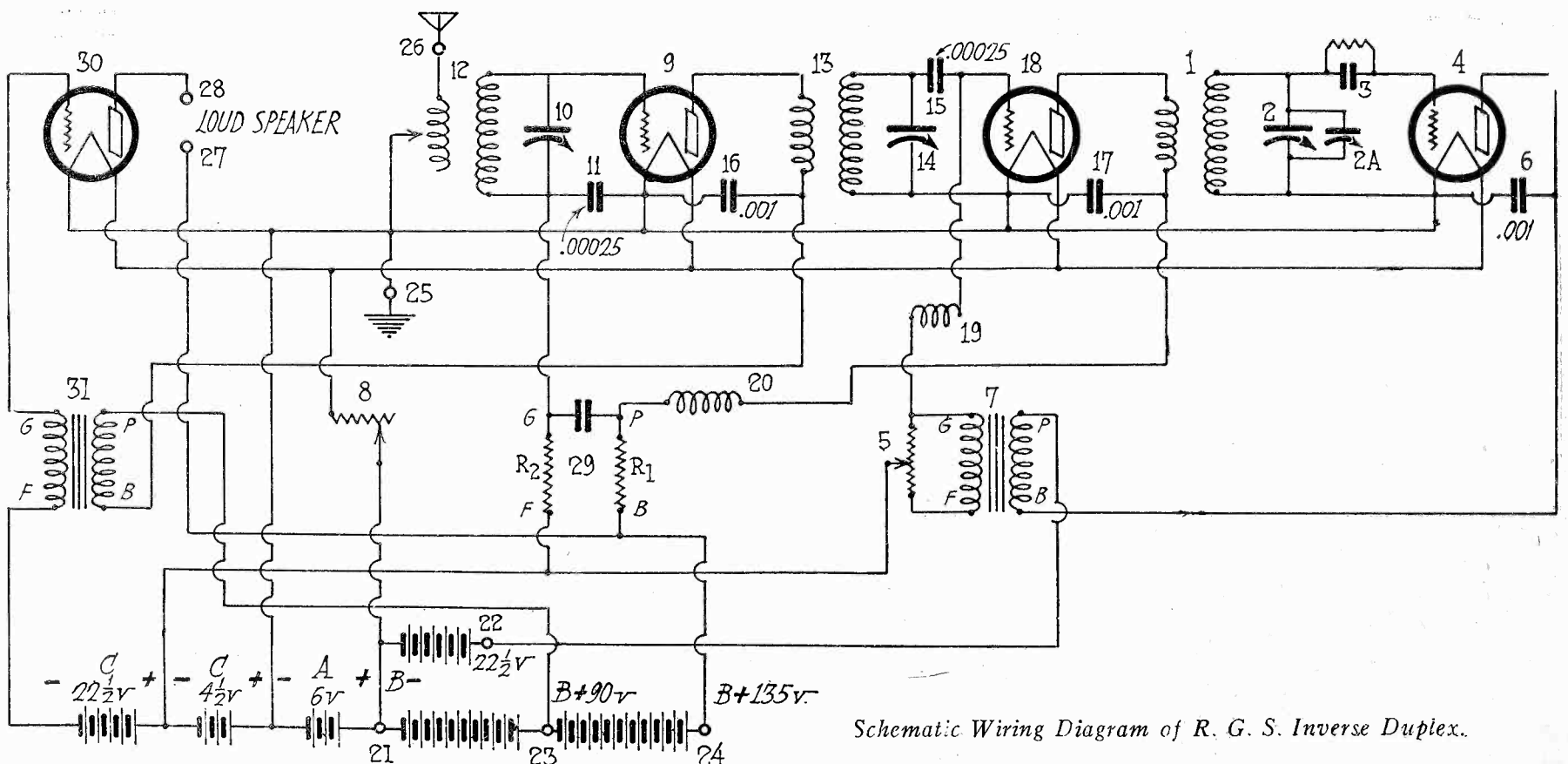

Schematic Wiring Diagram of R. G. S. Inverse Duplex.

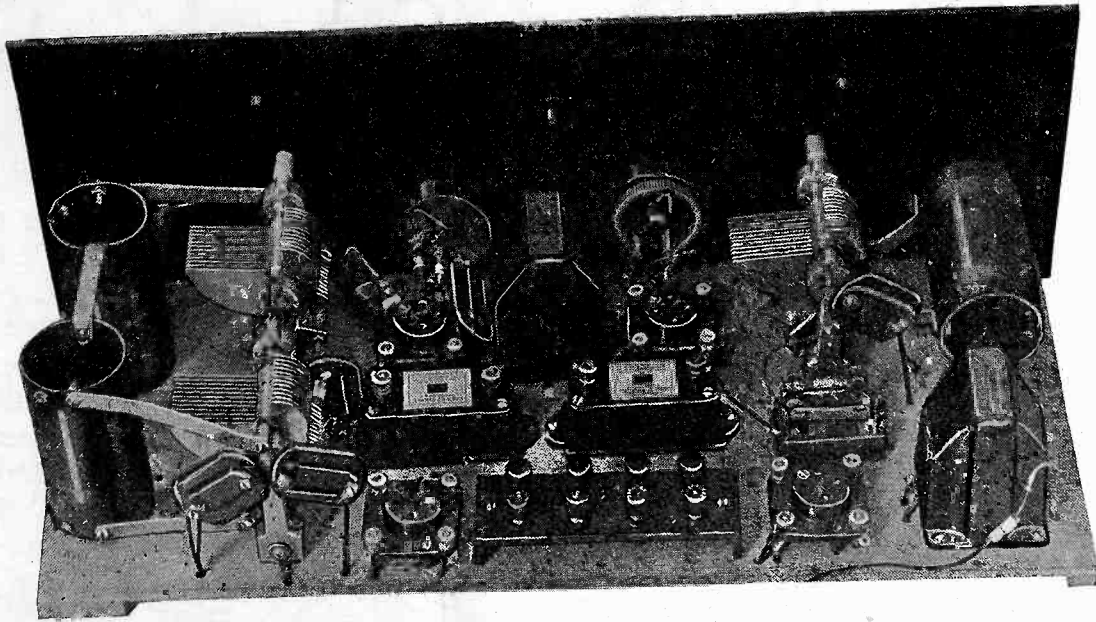

Rear View of R. G. S. Inverse Duplex.

The other listed parts were chosen because of their peculiar adaptability to the requirements of inverse duplexing.

The placing of the apparatus is a simple matter if the pictorial wiring diagram is carefully followed. Almost all the wiring of long leads can be run along the bottom of the baseboard directly between terminals, threading the wire through holes in the baseboard. The short grid leads should be run from terminal to terminal on the upper side of the baseboard. Cleats are placed at either end of the baseboard to keep the wires clear of the cabinet in which the set may be placed.

The battery connections should be made as shown, any variation being likely to reduce efficiency. A separate 22½-volt B battery unit for the detector is important to prevent noisy reception and whistling as the battery begins to run down. The use of 135 volts is

necessary for operation of the speaker and the use of a power tube is necessary to handle the input to the last tube properly. The use of 135 volts on the resistance-coupled stage will give very good results because of the drop in voltage that takes place in the resistance, giving a working voltage of about 70 volts to the second radio and first audio tube.

A 4½-volt C battery is required for the second audio tube, (9) and the first audio tube (18). An additional 22½-volt C battery connected in series with the 4½-volt C battery will give a total of 27 volts for the grid circuit of the power tube (30).

The set is ready for operation as soon as the antenna, ground and battery connections are completed, the tubes inserted and the speaker connected. The antenna switch should first be set on the No. 3 position. Set the volume control

about half way between its maximum right and left positions. Set the dials of the tuning condensers at zero, and the midget condenser knob, marked *Vernier* with the arrow pointing upward. The condenser should be set so that the arrow points upward when the rotary plates are half way into the stationary plates or at half condenser capacity and so that turning the knob counter-clockwise brings them further out of mesh, reducing the capacity, while turning it in a clockwise direction increases the capacity.

The battery control should be set so that the pointer points to the *Off* position when the shaft is turned as far as it will go in a counterclockwise direction. For operation the arrow should point upward, to start.

Now start tuning by turning the tuning condensers through their range, keeping them pretty much in step. A good plan is to vary one condenser a degree at a time and adjust the other condenser through a range several degrees on either side of the first condenser. The vernier adjustment can be used to clear up the signal after a station has been brought in.

For extreme selectivity when operating in congested districts the antenna knob should be set on position No. 2 or even on No. 1, thus shortening the antenna and increasing selectivity. For more distant stations and in receiving higher wavelength stations, the antenna knob may be set on the higher positions. On the higher positions sensitivity is increased at the sacrifice of some slight loss of selectivity, especially on the lower wavelengths.

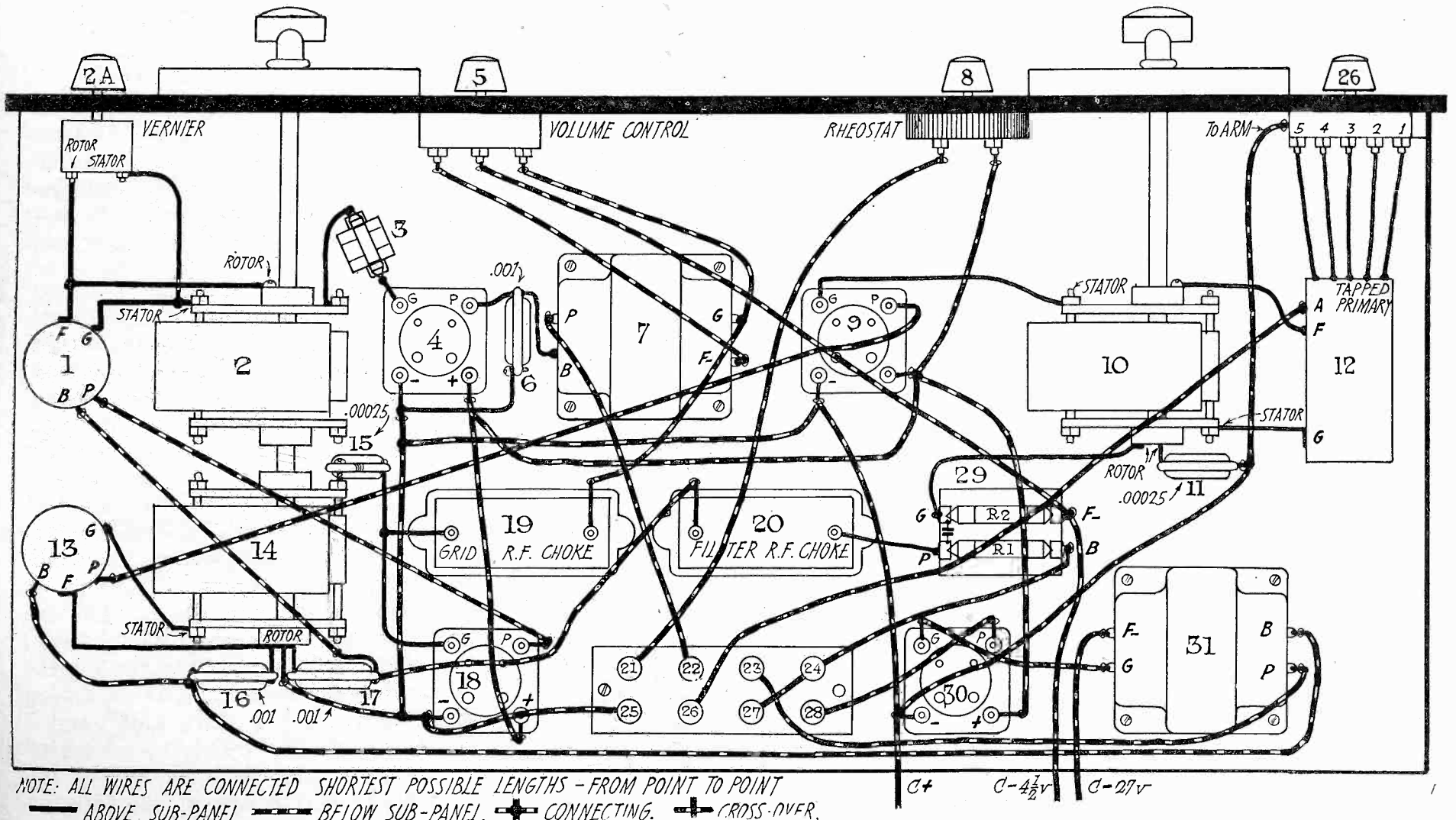

Pictorial Wiring Diagram.

Radio Parts Salvage

By Willis L. Nye

LIST OF PARTS FOR THE R. G. S. RECEIVER

Quantity	Part and Type	Reference No.
1	Micarta drilled and engraved front panel	
1	Grimes wood baseboard, drilled and finished	
2	National Vernier dials	
2	National-Grimes tuned radio frequency transformers	1, 13
1	National-Grimes two gang condenser	2, 14
1	General Radio Midget condenser	2A
1	Dubilier grid condenser, type 642, .00025 mfd.	3
1	Lynch, 2 megohm metallized grid leak	3
4	Benjamin, No. 9040, UX spring sockets:	
	1st radio and second audio stage	9
	2nd radio and first audio stage	18
	Detector	4
	Power tube stage	30
1	Centralab, 250,000-ohm modulator potentiometer	5
3	Sangamo, .001 mfd. fixed condensers	6, 16, 17
1	Samson, type HW-A3, 2 to 1 ratio audio transformer	7
1	De Jur, 2-ohm rheostat	8
1	Nat'l, .00035 mfd. National-Grimes variable condenser	10
2	Sangamo, .00025 mfd. fixed condensers	11, 15
1	National-Grimes, tapped antenna coupler with tap switch	12
1	Grimes, Grid R.F. choke coil	19
1	Grimes, Filter R.F. Coil	20
8	Eby, Ensign, engraved binding posts marked:	
	"A + B - Batt"	21
	"22½ volts +"	22
	"90 volts +"	23
	"135 volts +"	24
	"GND" (also serves as A-)	25
	"ANT"	26
	"Speaker -"	27
	"Speaker +"	28
1	De Jur resistance coupler	29
1	Lynch, .025 megohm metallized resistor	29R1
1	Lynch, 1 megohm metallized resistor	29R2
1	Samson, type HW-A3, 6 to 1 ratio audio transformer	31
1	Special set of Acme Flexible Celatsite leads	

The high cost of radio construction can often be cut by ransacking the junk box. A periodic clean-up and systematic arrangement of salvage parts will save many a dollar in the course of a year.

Fahnstock clips or small binding post taps should be stripped from old dry batteries. The secondary coil of an audio transformer whose primary is burned out makes a good resistance or choke coil, usually rating at from 15 to 20 henries in inductance and from 1000 to 5000 ohms resistance. It may also be used as an impedance in an impedance coupled amplifier.

Usually only one unit of a punctured filter or by-pass condenser will be found defective. This can be removed or shorted out and the condenser again used when a lower capacity is required. Unwrap the blown portion, connect new lugs to each remaining plate, and seal from moisture.

Small 1000, 2000 or 3000 ohm resistance units of low current carrying capacity can be taken from a discarded headphone. The magnets may also be removed for other uses.

An excellent form for fastening coils to bases can be made from the UX base of a burned out vacuum tube. After the glass and elements have been removed and the cement cleaned out, the connecting wires can be taken out by heating the prongs until the solder melts. The coils may be mounted as shown in the diagram.

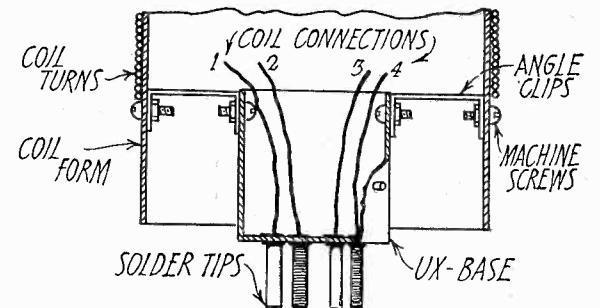

Fig. 1. Coil Plug with UX Base.

These renovated bases may also be used as plugs for connecting batteries to the wires from a set. The wires are run to a UX socket in the set and the battery connections to the old tube base, soldering them to the prongs. Removing the base disconnects the batteries.

Old r.f. transformers which are wound

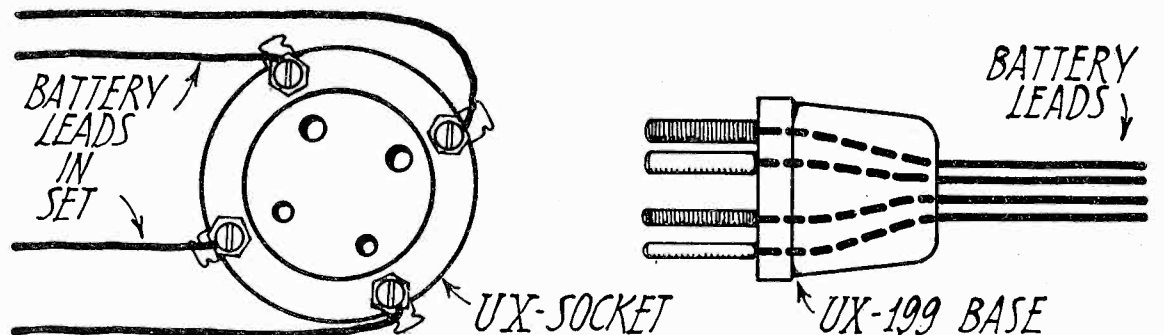

Fig. 2. UX Base and Socket Used as Battery Connection.

When the antenna knob is varied, a slight readjustment of tuning condenser (10) is required.

The use of the antenna knob on positions Nos. 1 or 2 on powerful local stations will give much better quality of reproduction since on these settings the reproduction includes the bass notes which are otherwise lost on the higher settings. For the same reason it is best to limit the plate voltage on the detector tube to 22½ volts. Higher plate voltage will give slightly greater sensitivity and

volume but the noise will increase and the quality will suffer.

If the volume control knob is turned too far in a clockwise direction, a moderately strong station will choke up the tubes and produce a "buzzing" sound. This will do no harm and may be eliminated by turning the *volume* knob in a counterclockwise direction until the noise stops.

on a film of celluloid and collodion can be cut down to give the requisite number of turns for plug-in short wave coils, fastening them to a plug-in jack and base. They also make good choke coils for the plate circuits of capacity feedback receivers or r.f. units.

Annunciator wire wound on a shel-lacked cardboard tube, or bakelite tube, makes a cheap and efficient inductance for radio receiving. Two holes should be drilled in one end of the cardboard tube, and the beginning of the winding threaded through them. The last turn is similarly secured. The wire should be drawn as tight as possible when winding. If it is not tight enough, the winding can be held in place by drops of collodion on the end turns. The inductance can be tapped after it is wound by raising a turn and slipping a piece of cardboard under it. The insulation is cut away with a sharp knife, and a six-inch length of the same wire soldered to the turn, and the other end of the lead connected to one of the taps on the switch.

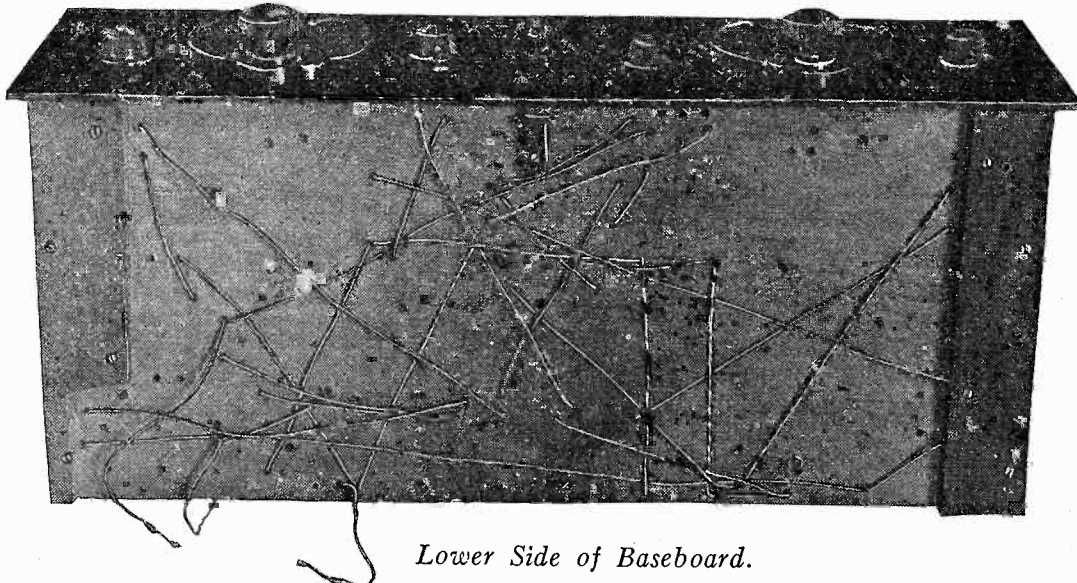

Lower Side of Baseboard.

Tracing Superheterodyne Diagrams

A Simple Explanation of Their Underlying Principles

By Lester I. Wiltze

BEFORE trying to understand the superheterodyne circuit it is assumed that the reader is familiar with the fact that the frequency of a broadcast station is equal to the number of waves or cycles radiated in one second. This is the same as the number of wavelengths occurring in a distance of 286,000 miles or 300,000,000 meters. Thus a 300 meter station radiates one million, or one-thousand thousand cycles a second, or 1000 kilocycles.

An understanding of a superheterodyne's action can be easily grasped by noting how it differs from that of a tuned radio frequency set, with which most of us are more familiar. The average tuned r.f. receiver has two radio

tical considerations in amplifier design place this frequency in the range between 30 and 100 kilocycles, although in a few instances frequencies as high as 300 kilocycles have been used. By changing the incoming frequency to a lower value, as above stated, it would be possible to use more than the customary two r.f. stages, and thus obtain a large increase in the amplifying power of the set. An added advantage would also be obtained in the fact that it is possible to design very selective tuned circuits in the frequency band between 30 and 100 kilocycles, so that not only increased range, but increased selectivity can be obtained.

Having these advantages in mind, an

of the frequency-changer, where they are mixed with the incoming oscillations. When this oscillator circuit is tuned so that it will emit waves of a frequency of 1,100 kilocycles, the output or plate circuit of the frequency-changer will be 100 kilocycles, (known as the beat frequency), which is the difference between the frequency of the broadcast station (1,000 kilocycles) and the oscillator (1,100 kilocycles). If the oscillator is tuned to 900 kilocycles the difference would still be 100 kilocycles. This is why each station comes in on two different oscillator-dial settings with the superheterodyne.

Now that the frequency has been reduced, three stages of radio-frequency

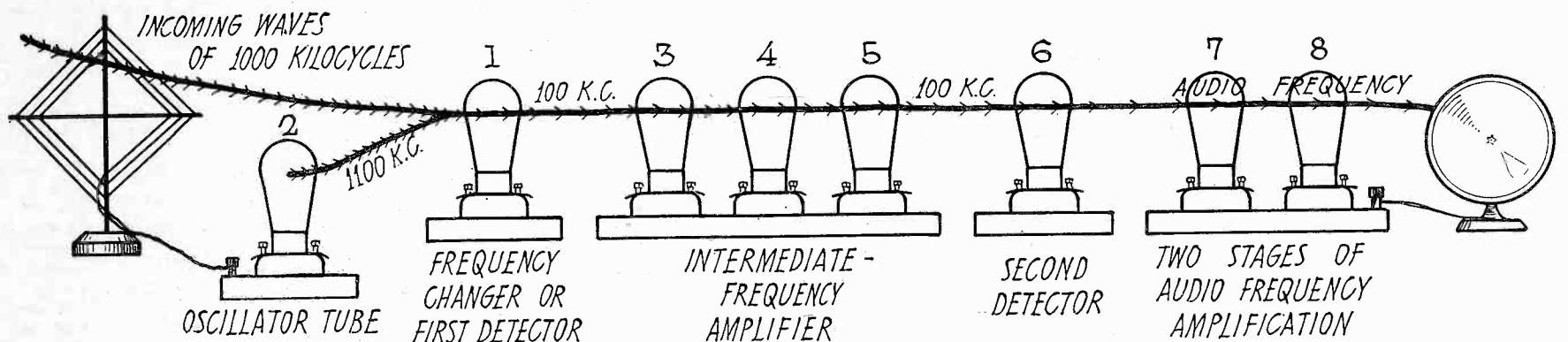

frequency amplifier tubes, a detector and two stages of audio frequency amplification. The incoming energy is amplified by the successive r.f. amplifiers, passes into the detector tube which separates the audio frequencies from the carrier upon which they were impressed at the broadcast station, and finally passes into the audio amplifier, to be amplified and fed into the loud speaker.

Since the efficiency of a vacuum tube increases as the frequency of the wave it is amplifying decreases, it is obvious that there would be a great advantage in changing the frequency of the incoming signal to a lower value, before amplifying. This value should lie somewhere between the frequency band used in broadcasting, (550 to 1500 kilocycles) and the audio frequency band, whose upper limit is 17 kilocycles. Prac-

Fig. 1. Path of Signal in Component Parts of Superheterodyne.

analysis of the superheterodyne circuit, using conventional diagrams, will be given, an eight tube circuit being selected as an example. The skeleton drawing in Fig. 1 depicts the functions of the various tubes, the circuit being divided into sections for convenience, the line with attached arrow-heads representing incoming waves from a broadcast station.

Let us assume these waves come from a 300-meter station, a frequency equivalent to 1,000 kilocycles. First, they are picked up by the loop aerial, then pass to the grid of the tube No. 1, called the first detector or frequency-changing tube. Tube No. 2 is the oscillator tube, and is really a miniature transmitter sending oscillations or waves to the grid

amplification can be employed, resulting in extreme sensitivity. These three stages comprise the intermediate-frequency amplifier, represented by tubes marked 3, 4 and 5. Before proceeding to the next section we will ascertain just what constitutes this amplifier and how it works.

Fig. 2 shows a "close-up" of the transformers and tubes which form the intermediate-frequency amplifier. The output, or plate, of the frequency-changer tube is connected to the primary coil of the first intermediate-frequency transformer A. Its primary and secondary coils for this theoretical case of a 100 kilocycle amplifier, are wound so they will respond to a wide band of frequencies above and below 100 kilocycles. We have seen how the frequency of the incoming waves was

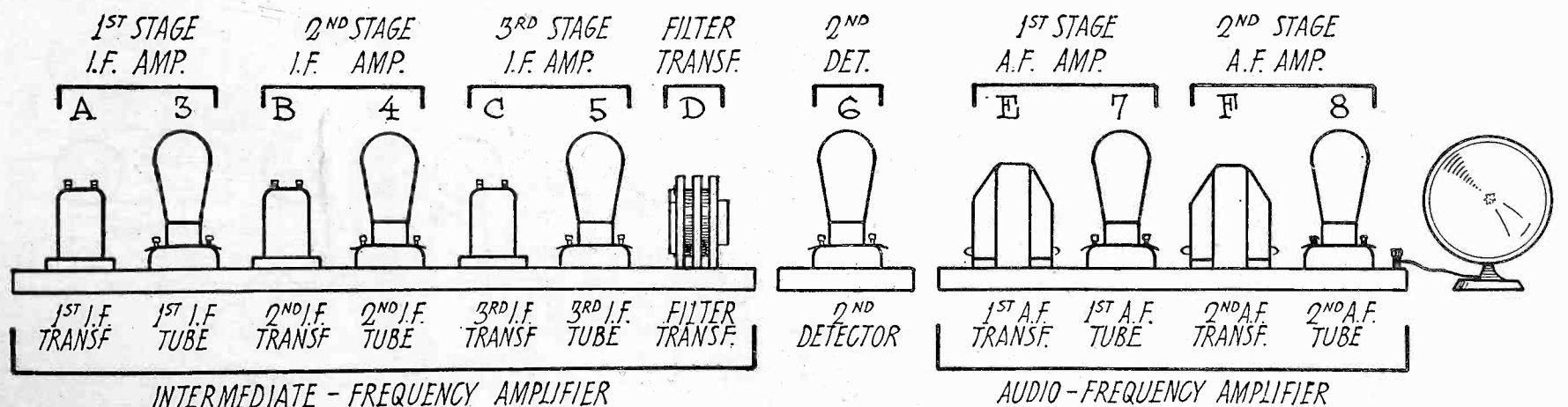

Fig. 2. Arrangement of Amplifiers.

changed to 100 kilocycles, so they pass through transformer *A* and tube 3 which comprise the first stage of amplification. Transformer *B* and tube 4 constitute the second stage, and transformer *C* with tube 5 is the third stage. These three transformers, *A*, *B* and *C*, are identical.

The next one *D*, is known as a filter transformer. Its purpose is to filter out all frequencies except the desired ones. It controls the selectivity of the set. Unlike the others it is tuned, which is usually accomplished by connecting a fixed condenser across either the primary or secondary windings, sometimes both. In this particular circuit we find we can get the highest rate of amplification and selectivity when our filter transformer is tuned to 100 kilocycles, and we need not adjust it again. So if this is tuned to pass frequencies of 100 kilocycles the oscillator circuit has to be adjusted to either 100 kilocycles above or below the frequency of the desired station, otherwise the filter would not pass it on.

After passing through the filter transformer the signals go to tube 6, the second detector, which rectifies them in the usual manner, the following transformers and tubes labelled *E*, 7, *F* and 8, comprising two stages of audio-frequency amplification.

Some circuits have the filter transformer between the frequency-changing tube and the first intermediate-frequency amplifier tube, in other words at the *input* of the I.F. amplifier. This is referred to as a *tuned input* to differentiate from the *tuned output* pictured in Fig. 2. This depends upon the preference of the designer, both methods giving satisfactory results, although less tube noise will reach the second detector if the filter is placed just ahead of it.

Superheterodynes usually employ a loop aerial as the circuit is exceptionally sensitive, and the loop has sufficient selectivity due to its directional qualities. If this circuit is used with an outdoor antenna the oscillator, being a small transmitter, will send out its waves, causing your neighbors' sets to howl and whistle. Therefore a loop is generally recommended, as it minimizes radiation or else a stage of tuned r.f.

amplification should precede the first detector.

Before considering the schematic diagrams it is assumed that the reader is familiar with the radio symbols. Otherwise it is advisable to study the group published in the October, 1926, RADIO on page 23, before proceeding.

Fig. 3 shows a conventional circuit diagram of an eight-tube Best superheterodyne. The tubes and transformers are designated by the same numbers and letters as the corresponding units in the picture diagrams, permitting reference to the latter when in doubt.

The loop aerial at the left, in conjunction with the variable condenser C_1 (usually called the antenna condenser) is designed to respond to signals of stations within the broadcast wave band. Note that variable condenser C_1 is shunted across the loop. This condenser, when tuned to the desired station's frequency allows its signals to pass on to the grid of tube No. 1, the frequency-changer. By following the line from the top connection of the loop, through coil L_1 , towards the grid of the frequency-changer we see the path the incoming waves traverse. For the present we will leave them at the grid.

No. 2 is the oscillator tube. Observe the two coils, L_2 and L_3 , the former being connected to the grid of the oscillator tube and the latter to its plate. As they are drawn beside each other we know they are inductively coupled, causing the tube to oscillate. The oscillations are governed by variable condenser C_2 , shown in series with the two coils L_2 and L_3 . So if we turn the dial controlling this condenser C_2 (known as the oscillator condenser) we vary the frequency of the oscillations sent out by the oscillator tube. Coil L_1 drawn just above is termed the pick-up coil because it picks up the oscillations generated in coils L_2 and L_3 ; in other words the current is induced into coil L_1 . Then the oscillations or waves have a clear path to the grid of the frequency-changing tube where they meet the waves of the broadcast station to which the antenna condenser is tuned.

By a complicated action, too involved to explain in detail without resorting to mathematics, the output frequency of the plate circuit of the frequency-

changer is the difference in the two frequencies applied to its grid. This process is termed heterodyning, "hetero" meaning "different" and dyne signifying "power." Assuming the broadcast station's frequency is 1000 kilocycles and the oscillator is tuned so as to emit waves of 955 kilocycles, the plate frequency will be $1000 - 955 = 45$ kilocycles, so we see the frequency has been greatly reduced. The reason why we adjust the oscillator within 45 kilocycles of the incoming station's frequency is because our filter transformer *D*, between tubes 5 and 6, is tuned to pass frequencies of 45 kilocycles only, so our beat-frequency must be 45 kilocycles to pass through the filter.

Now we will trace the wire leading from the plate (output) of the frequency-changing tube. It goes to the right, then straight down and turns to the left, where it connects with a small variable condenser C_3 , thence directly to the lower end of the loop. If the plate circuit is tunable it is regenerative, and condenser C_3 being in series with the plate of the frequency-changer (or first detector) and the loop, informs us this has a regenerative first detector. So our reduced frequency from the plate goes to and through the loop aerial, back over the coil L_1 and again to the grid of the frequency-changer to be amplified by it. This tube handles the oscillator frequency, the broadcast station's frequency and the sum of a difference between the two, *all at the same time*. Rather mysterious? Not when we consider that all frequencies are numerically far apart. In this case it accepts frequencies of 1000, 955 and 45 kilocycles.

The 45 kilocycle beat-frequency leaves the plate of the frequency-changer and travels to the primary coil of the first intermediate-frequency transformer, marked *A*, is induced into the secondary coil in the usual manner, and follows the wire to the grid of the first i.f. tube (No. 3) where it is amplified again. The second i.f. transformer *B* and the second i.f. tube 4 amplify the output of the preceding stage in like manner. The next i.f. transformer *C* and tube 5 comprise the third and last stage of the intermediate-frequency amplifier.

Before proceeding further we will re-

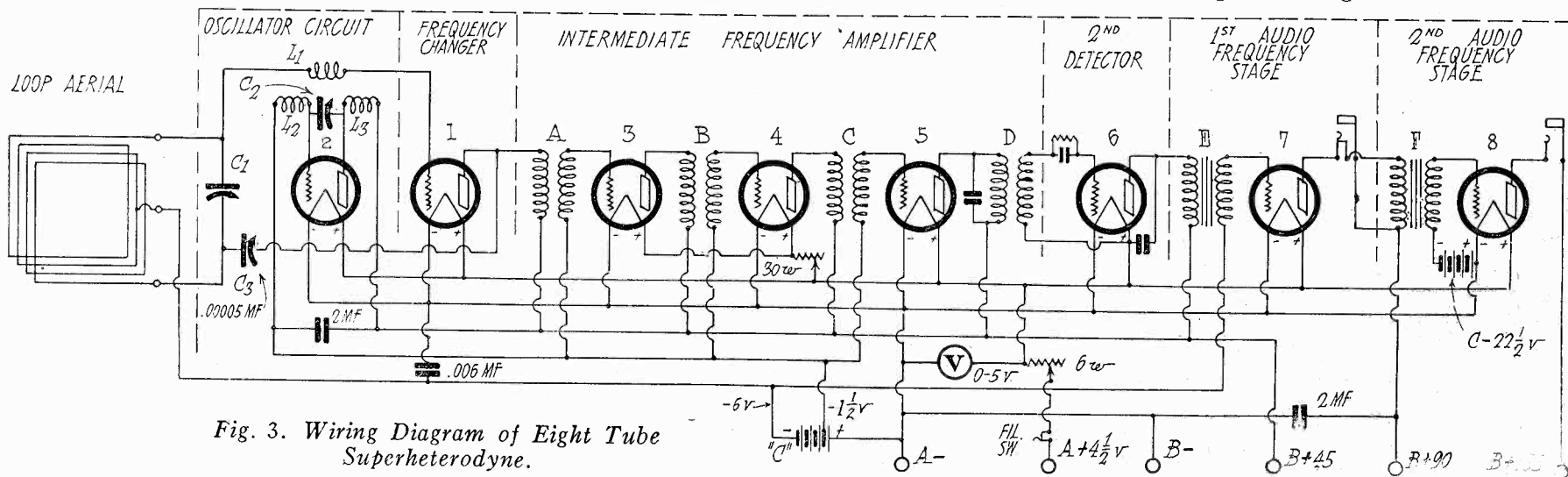

Fig. 3. Wiring Diagram of Eight Tube Superheterodyne.

turn to tubes 3 and 4, which are the first and second i.f. tubes, respectively. If we start at the filament of tube 3 and trace the lead on the right (being the positive lead) we come to the symbol for a variable resistance, which happens to be a 30-ohm rheostat. The corresponding wire of tube 4 also connects with this rheostat, indicating it controls the amount of filament or *A* battery current to these two tubes. This rheostat governs the intensity of the signals delivered to the loud speaker as it can readily be seen that by decreasing the filament voltage of tubes 3 and 4 it would reduce the amplification of these two stages. So the following four tubes would have weaker signals to handle. Therefore this 30-ohm rheostat is the volume control of the entire set.

We left off at tube No. 5, didn't we? Tracing the wire from its plate we come to the primary of the filter transformer *D*. Observe the fixed condenser symbol which is shown connected across the filter primary. This condenser is of the correct capacity to tune the filter sharply at 45 kilocycles. In case local conditions are not favorable to that frequency, it is only necessary to substitute another condenser of different capacity. That would alter the frequency to which the filter would respond, so we would have a different oscillator-dial setting, because of the changed beat-frequency.

Taken as a whole, the units we have traced thus far have reduced the incoming frequency to such an extent that we were able to employ three stages of radio-frequency amplification. Now we are ready to detect, or rectify the signals; in other words, to change them into audio frequencies.

Following the wire leading from the top of the filter secondary coil we come to the symbol for a fixed condenser with a grid leak (resistance) shunting it. We know that when a grid leak and condenser are in the grid lead of a tube the latter is a detector. To differentiate between the frequency-changing tube, which is often called the first detector, this tube 6 is termed the second detector. After passing through this tube the signals are audible and can be heard on a headset.

In order to work a loud speaker satisfactorily with plenty of volume for both

distant and local stations, two stages of audio-frequency amplification are used. Transformer *E* is an a.f. transformer, judging by the symbol with the lines representing the iron core between the coils. Tube 7 with transformer *E* is the first stage of a.f. amplification. The jack symbol in the plate lead of tube 7 informs us we can plug in after the first stage for nearby stations with strong signals. The next transformer *F* and tube 8 constitute the second and last a.f. stage. By following the plate lead of the last tube (No. 8) we find another jack symbol. If we should plug in our loud speaker here we would get maximum volume on all stations, providing our volume control is turned up to its limit.

Having traced the diagram from loop aerial to loud speaker we will concentrate on the lower connections. Starting on the extreme lower right of the diagram we see a binding post (symbolized by a small circle) with +135V marked beneath, meaning "positive 135 volts." This is where the positive wire of a 135-volt *B* battery connects. The next binding post to the left accommodates the wire from the 90-volt post, the third post connecting with the 45-volt tap, and the fourth binding post from the right, labelled *-B*, attaches to the *-B* connection on the battery, and so on. As the filament, or *A* battery, is never higher than 7½ volts in present day receiving sets it is unnecessary to mark the positive plate-battery leads with the letter *B*. Fig. 4 shows the binding posts and the method of connecting the batteries to them.

By following the wire leading up from the *-B* binding post, then over to the left, we see it connects to the *-A* filament wire. Sometimes a common binding post is used for both wires. All circuits are similar in this respect, as the *-B* lead must join one of the filament wires, likewise each *+B* wire should connect with the plate of a tube.

At the bottom of Fig. 3 the symbol for a battery can be seen, with the letter *C* printed below it. This is the *C* battery, the smallest in size (but not voltage) of all batteries in the circuit. Its purpose is to supply a negative potential on the grids of tubes to pre-

vent undue distortion and at the same time to conserve the *B* battery. The wire leading from the *negative* side of the *C* battery should always connect to *grid*. We will confirm this by beginning with the grid of tube 2, and tracing through coil *L*₂ directly to the $-1\frac{1}{2}$ volt tap of the *C* battery. That's O.K. Follow the grid lead of tube 1, over coil *L*₁ through the loop aerial to the center tap, and we finish at the -6 v. side. The intermediate-frequency amplifier tubes numbered 3, 4 and 5 all have their grids attached to the $-1\frac{1}{2}$ volt connection.

The second detector does not require any *C* battery because the grid leak and condenser are used instead. The latter method could be utilized for the frequency-changer tube also, as it is the first detector. The grid of tube 7 is connected to the -6 volt end of the *C* battery through the transformer secondary. The final tube employs a *C* battery of higher voltage ($22\frac{1}{2}$ volts), it being a power tube with 135 volts on its plate. The *positive* end of the *C* battery must unite with the *-A* wire. See if it does.

Although basically the same, there are many variations of the superheterodyne ranging from five to ten tubes. For instance, in some circuits one tube acts as both oscillator and frequency-changer and others use only one or two stages in the intermediate-frequency amplifier, or perhaps one stage of audio-frequency amplification. Circuits of more than eight tubes generally have one or two stages of r.f. amplification *before* the frequency-changer or employ push-pull a.f. amplification, the latter requiring two tubes and two transformers for *one* stage. However, the principle remains the same irrespective of number of tubes incorporated.

A few multi-control supers have variable condensers across either the primary or secondary coils of each i.f. transformer in order to tune them all sharply to the desired beat-frequency. Some use the tickler-coil method of regeneration instead of the condenser in series with the plate and tapped loop.

The resistance comprising the volume control is often seen connected across the primary or secondary of one of the intermediate-frequency transformers in place of in the filament circuit. Both iron core and air core transformers can be used for the i.f. amplifier; the former is perhaps the most prevalent.

All these variations are easily discernible in a diagram once we have traced a circuit. While many superheterodyne receivers have three or more dials and knobs there are only two major tuning controls necessary, one to tune the loop aerial to resonance with the incoming waves and one to control the oscillator circuit.

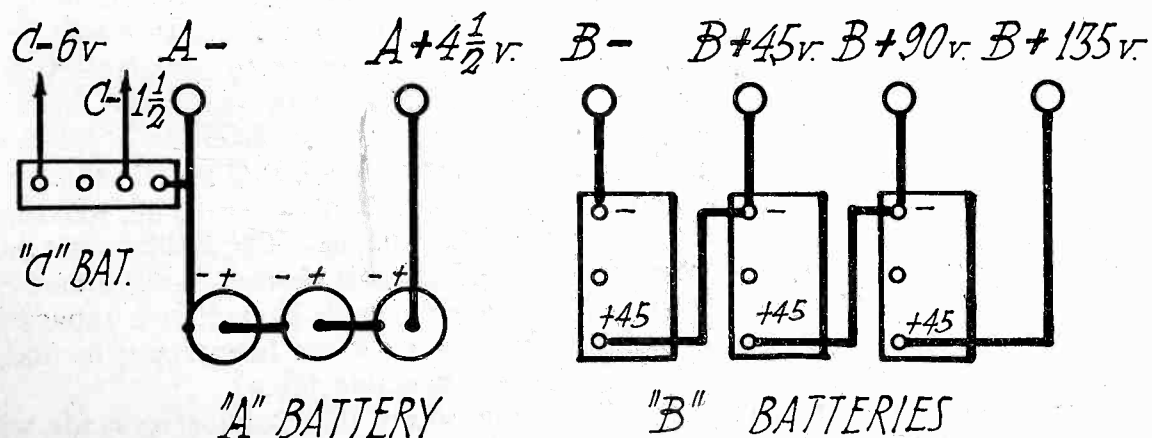

Fig. 4. Method of Battery Connection.

Experimental Shop Accessories and Methods

By Samuel G. McMeen

THE outstanding difference between a commercial and an experimental shop is that the former turns out a large number of identical things while the latter makes but one of a kind of various things. With an experimental shop equipped as described in February RADIO, the worker is ready to make or buy a few accessories to complete his equipment.

First among these is a set of taps and dies for making screws and screw holes in metal, bakelite, hard rubber or wood. As a suitable screw can always be found in standard sizes they can be bought rather than made.

The cost of a set of taps can be reduced by making them from Stub's drill rod of the same diameter as that of the needed tap, measured over the thread. The thread is cut by running a die of the selected size over the drill rod, using plenty of lard oil as a lubricant. The threaded tap can be flattened off in three places with a file or three slots can be cut by a milling machine.

To harden, the threaded portion is heated in a bunsen flame until cherry red, and then quenched in cold water. It will now be glass-hard, and will be of a gray color. Brighten a portion of the end of the tap on the emery wheel, on a carborundum disk or on sandpaper. Heat the tap again in the flame, cautiously, and watch the brightened portion. It will color gradually, from a very light yellow through a succession of darker colors down to a deep blue if it were to be heated long enough. But we do not want to go as far as that. As soon as the color arrives at a light brown, stop the further progress by quenching in cold water.

What we have done in the two heatings and quenches is to harden entirely and soften partially the bit of steel that forms the tap. It is now hard enough to cut well and to withstand breakage to the greatest degree consistent with that cutting hardness. If it had been left glass-hard it would have snapped off in the hole the first time of tapping. If it had been softened to the non-breaking point it would not have cut hard metal. Hence the importance of the color selection in the temper-drawing process.

An admirable tap for use in hard rubber is one that is threaded but not grooved or flattened. Instead, the tip of the round tap is ground off at an angle of from 30 to 45 degrees with the axis of the tool, and this ground-off portion starts the thread as it enters the work. The sides of the wedge-shaped part cut the thread and the following completely threaded portions of the tap

merely compress and polish the completed thread.

In tapping metal, great care is necessary to avoid breaking the tap. But this care is confined to the one requirement that the tap be not forced, and the technique that avoids danger of breaking is not hard to acquire. To avoid the danger, turn the tap just far enough to meet considerable resistance, then turn it back about a third of a revolution, then ahead again till it is resisted strongly, then back again. The whole secret is in learning just where to stop and how far to go in each direction. Err on the side of safety.

In cutting threads with dies the same back-and-forth process is followed, but there is less danger of breakage, as a die is sturdier than a tap.

In the interest of accuracy and convenience it is well for the experimental shop worker to have at hand a printed or lettered list of drill sizes for threading and clearing. Never guess at the size of a tap for a given thread.

Lathe tools may be ground on a carborundum wheel, on a carborundum disk based on cloth, or even on a garnet disk based on paper. In any grinding of such tools, it is to be remembered that the tool ought to clear the work at all points except at the cutting edge. This means that the cutting-off tool, for example, must have a taper two ways: One such that the sides of the tool, as seen from above, will taper back from the front cutting edge, and the other such that the bottom of the tool will be narrower than the top. In such a case, and in that case only, will the cutting-off tool do its work cleanly, accurately and without heating.

The same principle of clearance applies to all other lathe tools, though there is no example as exacting as that of the cutting-off tool. Fortunately the clearance is perfectly easy to attain, requiring only that the need be appreciated and the necessary care taken to get it.

The setting of the lathe tool with reference to the axis of rotation is also an important point. This setting should be very close to that axis—in other words, on a level with the horizontal plane between the centers of the headstock and the tailstock. The limits of this tool-setting are a little above and a little below that plane. If the tool chatters or otherwise behaves unsatisfactorily the setting will most often be at fault and a slight change will make all well.

Various laboratory supports such as rods, clamps, tripod bases, and face plates are indispensable in the experi-

mental shop. These devices are sold by the piece, not in sets, so that the equipment may be modest or elaborate, depending upon the need and the state of the exchequer. They save many a session at the machines in making something that could have been temporarily assembled from the supports.

Another useful device is a universal drafting machine, which simplifies the making of working drawings. Even the simplest part should be sketched before being made.

Parts can be stuck together for temporary purposes with Universal cement made by melting four parts of white wax with one part of Venice turpentine (by volume), mixing well and adding just enough dry Chinese vermilion to give a strong red color. Mold the mixture into sticks, heating the end of the stick to melt off what is needed. A stronger union will be given by ferrule cement, used to fasten fishing rods. In either case the pieces to be attached should be heated.

Most fish glues absorb moisture from the air and their joints often come apart in damp climates. A moisture-proof glue for wood can be made from Russian isinglass which comes in the form of leathery sheets of great toughness. Soak 2 ounces in cold water for a couple of days till it is quite soft. Soak 2 ounces of Cooper's A Extra white glue fifteen minutes in cold water. Pour the water off from both materials and melt them together in a water bath—a glue pot with an outer jacket containing water. Cook the mixture till it is as thick as possible without drying out entirely. Then add enough of a mixture of half alcohol and half water to thin the glue till it will just drop from a pointed stick. Now add to each fluid ounce of the mixture 5 grains of gum mastic, dissolved in the least possible quantity of alcohol, and 5 grains of gum ammoniac, dissolved directly in the hot mixture. Bottle for keeping, and heat the bottle in water when needed for use.

We admit frankly that this reads like a formidable process, but it is actually simple, and the glue thus made is so strong and so generally satisfactory that we urge the adoption of the method. The Cooper's glue itself is a most excellent adhesive, but is greatly improved by the addition of an equal weight of Russian isinglass. The latter is not easy to find in the market, and sometimes the dealers who have it are rapacious. There is a sort of lure trying to find it at a reasonable price.

For joints that cannot be made with hot glue, a good water-resistant, cold-

(Continued on page 60)

A Phonograph Cabinet Receiver

Single Control R. F. Tuner with Three Stages of Impedance Coupled Audio Amplification

By Perry S. Graffam

A HIGH quality receiver can be assembled on a vertical panel so as to fit the record compartment of a console phonograph. The best quality of tone reproduction can be had with three stages of impedance coupled audio amplification and ease of operation by using one vernier dial to turn a tandem condenser for tuning the r. f. and detector circuits. By the use of a sub-panel, construction is simple and compact.

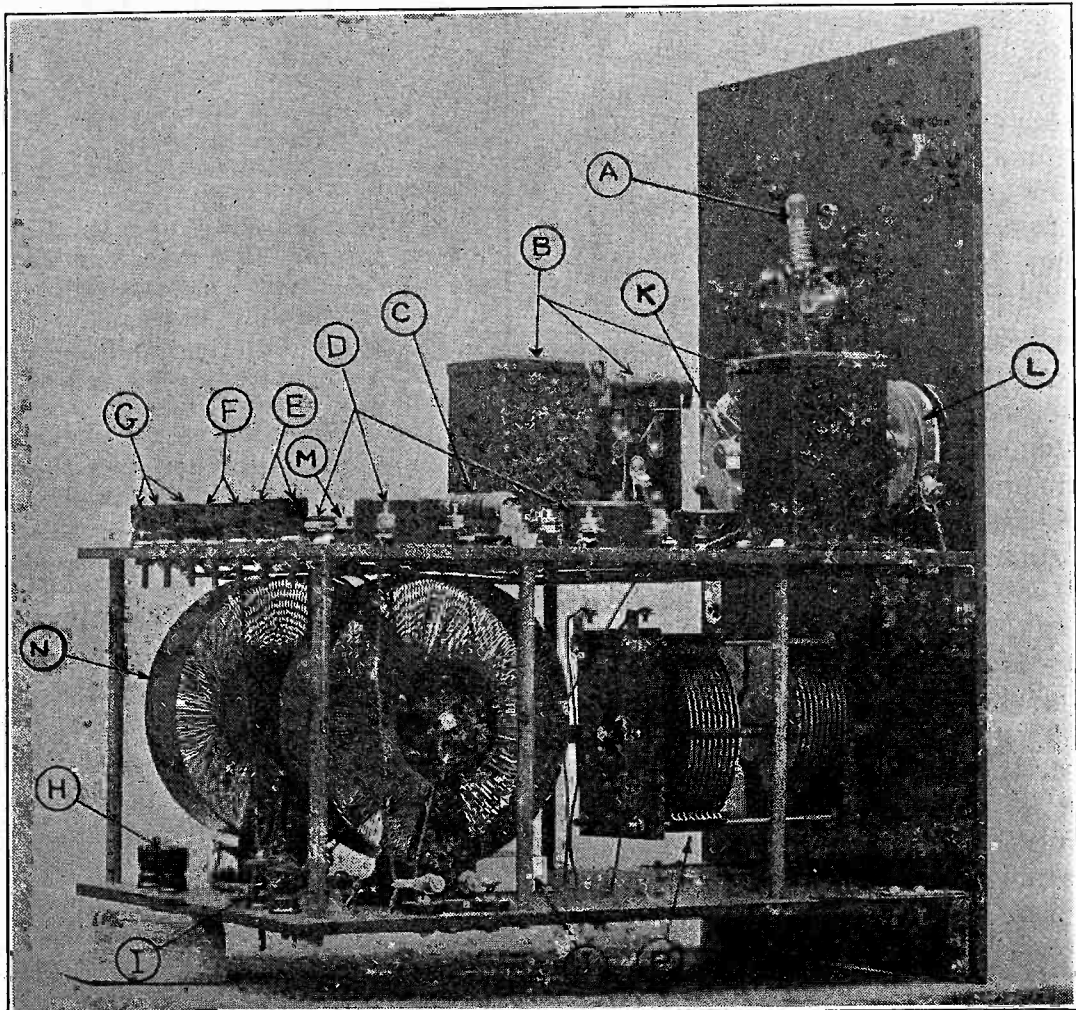

Rear Side View of Complete Receiver.

A pilot light and battery switch; B Impedaformer; C Amperites (not used); D R. F. Detector and Last Audio Sockets; E "A" battery posts; F "C" battery posts; G "B" battery posts; H loud speaker posts; I antenna and ground posts; J 1 mfd. by-pass condenser; K detector and amplifier rheostat; L radio frequency rheostat; M .002 mfd. fixed condenser; N Toroid coils; P tandem condenser.

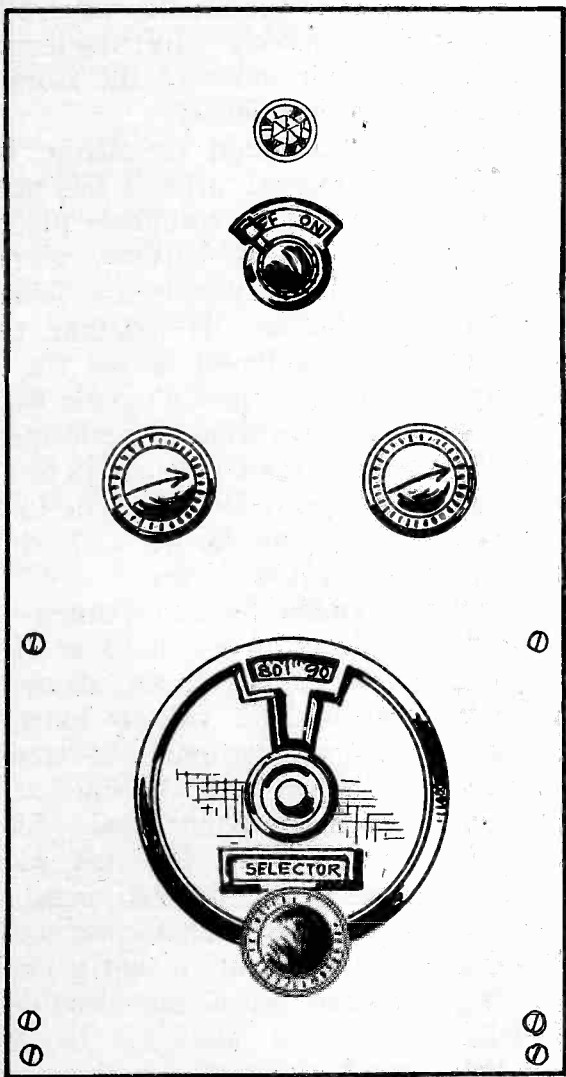

Arrangement of Front Panel.

As may be noted from Fig. 1 the circuit here employed has a negative grid bias detector. The r. f. coils have restricted fields.

The vertical panel is 7 by 21 in. in the model illustrated, but may be modified to fit the cabinet into which it is to be placed. The filament switch is at the top, the filament control for the r. f. tube at the left, and for the detector

and amplifier tubes at the right. The tuning condenser appears at the bottom. A pilot light may be also placed at the top to indicate "on" or "off."

The general arrangement of the parts and the construction of the sub-panel is evident in the rear side view of the completed model.

The single stage of r. f. amplification

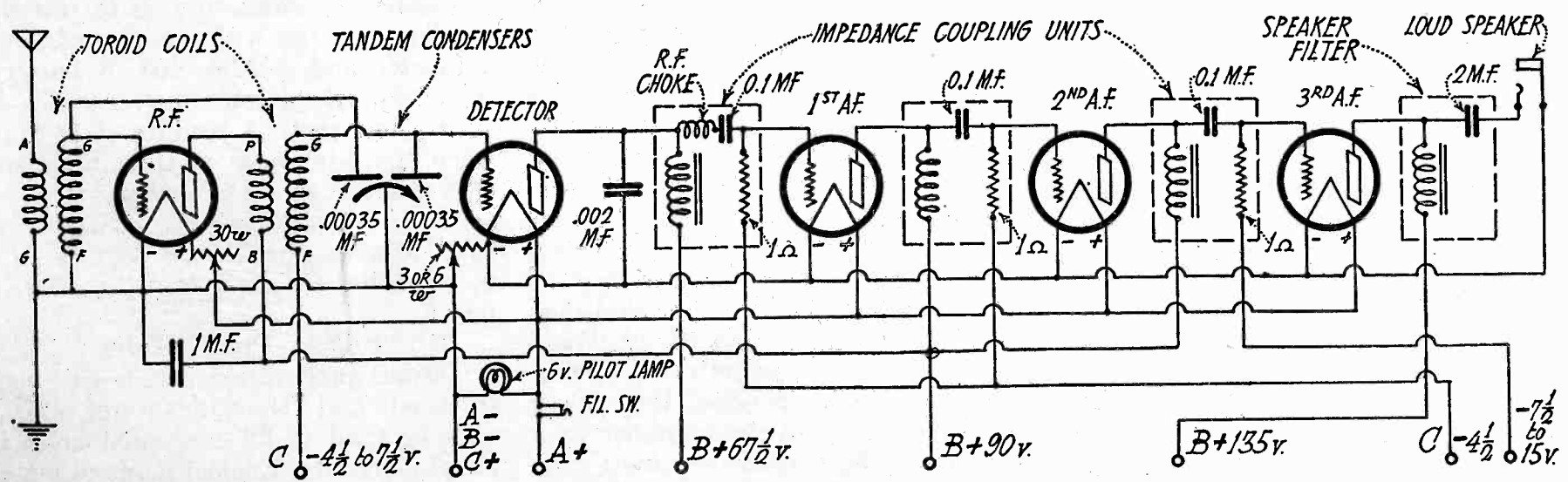

Fig. 1. Schematic Wiring Diagram for One Stage R. F., Non-Regenerative Grid Biased Detector, and Three Stages of Impedance Coupled Audio Amplification.

enables the use of a small indoor or outdoor antenna and provides selectivity for satisfactory local reception. Toroid coils are used to minimize interstage coupling and signal pick-up.

A detector with negative grid bias instead of grid condenser and leak is used to avoid possible overloading and consequent impairment of tone quality from strong local signals.

As the set is intended for use with a high grade reproducing unit or loud speaker, impedance coupling is used so as to give the full value of the low notes. Impedaformers are used for coupling as they combine the choke coil, isolating condenser and grid leak in one unit so as to minimize wiring connections. Any standard type of choke coil, condenser, and grid leak may be substituted.

Good results will be had with 90 volts plate on 201 A tubes. If in the first and second stages, high-MU tubes are used together with a 112 or 171 in the last stage tone, quality will be improved as well as increased volume obtained. With such a tube in the last stage it will be necessary to increase the plate battery to 135 volts or more and the C battery bias to from 7 to 15 volts. This arrangement is shown in the circuit diagram.

Since this increased B battery voltage would be ruinous to the loud speaker windings, an output transformer or choke coil and condenser should be used as shown in diagram of circuit. This output filter tends to hinder the flow of direct current but allows the a. c. signal voltage to flow, thus allowing the diaphragm to swing freely in synchronism with the signal impulses.

Since the receiver may be constructed in any desired form to fit the individual requirements of the phonograph cabinet in which it is to be placed no dimensions are given, other than to state that this particular model fits the left hand record compartment of an Edison Console model. If desired, the phonograph arrangement may be departed from as this receiver makes a very satisfactory looking outfit when built into a cabinet in the ordinary manner.

Substitutions for the parts used in constructing the model shown may be made as the judgment and choice of the builder directs. In any event, good material should be used for best results.

The wiring is not difficult and may be made under each subpanel with No. 20 double silk or cotton covered wire. In all the wiring, leads should be connected to the different points by as short a path as possible. If insulated wiring is used no danger from short circuit will be encountered. The plate and grid leads must be as short as possible and must not be too near other leads. The receiver as shown is arranged for 201 A tubes in the radio frequency and detector and for MU-20 in the first stages

LIST OF PARTS

- 1—Front panel $8\frac{1}{8} \times 11\frac{5}{8} \times 1\frac{3}{8}$ in.
 - 2—Sub-panels $8\frac{1}{8} \times 12 \times 1\frac{3}{8}$ in.
 - 6—Fiber tubing rods $\frac{1}{4} \times 5\frac{1}{4}$ in. ea.
 - 1—Centralab rheostat. If 201-A tubes are used 6-ohm, otherwise a 3-ohm.
 - 1—Centralab rheostat 30 ohms.
 - 1—General Radio tandem condenser type 248 N.
 - 2—T-2 All American toroid coils.
 - 1—Yaxley filament switch.
 - 5—Silver Marshall sockets, type 511.
 - 3—National impedaformers.
 - 1—National choke 100 henries and 1 2 mfd. condenser.
 - 1—General Radio speaker filter type 367.
 - 1—Silver Marshall Vernier dial.
 - 1—Sangamo .002 mfd. condenser.
 - 1—Tobe 1 mfd. condenser.
 - 12—Eby binding posts.
 - 1—Yaxley battery cable—10 ft. for all battery connections.
 - 5—Tubes as required.
- An assortment of 6/32 in. screws, and nuts, together with the necessary wire, tubing and solder for wiring the set.

of audio and a 112 in the last stage. While the current consumption is not as low as might be desired, this drain is absolutely essential if the highest quality of reproduction is to be obtained; but it is assumed that the builder of this receiver is willing to go to some slight expense which will be amply repaid by the quality of the reproduction obtained. However, very good quality and volume will be had by the use of 201 A type throughout.

A small lamp near the top of the receiver indicates through a red glass opal when the filament current is turned on. This pilot is not just an ornament but will often be found a valuable reminder to shut off the battery current when the radio is abandoned in favor of a few phonograph selections.

It may be necessary to make minor changes in the grid bias or C battery and the detector B battery voltage, this being most readily determined by experiment.

An antenna of from 50 to 100 ft. may be used with the receiver either indoors or outdoors, an indoor antenna being suitable for the reception for which the receiver was designed. The tuning of the set is done by the large vernier dial. Set the rheostat at the right of the panel as little on as is necessary without the loss of quality in order to conserve A battery current and tube life. The left rheostat controls the radio frequency tube and should be turned on to a point just below where the signals are distorted due to overloading the tube. Bear in mind that for more than average volume, the power tubes referred to must be used. Using these tubes will increase the power handling capacity of the amplifier to a point where the maximum volume cannot be tolerated in the average residence.

Increasing the detector filament current will not materially increase signals without distortion—always remember that amplification is a function of the amplifier and the detector should not be called upon to do any more than its own particular job of detecting.

SOME RADIO POINTERS

By Harry A. Nickerson

Testing Fixed Condensers

Perhaps the simplest test for leakage in a fixed condenser is to put it in series with a 45 volt B battery and a voltmeter. If the needle shows a continued deflection, the condenser is probably defective.

If a condenser is charged by being placed across the terminals of a 45 volt B battery, it will register a voltage when it is subsequently discharged by having its terminals placed across the terminals of a voltmeter. This discharge will merely swing over the needle, which will then drop back quickly. But the length of swing is a fair index of the storage capacity of the condenser.

It should also retain its charge for an appreciable period, after it has been charged by having its terminals placed across a 90 volt B battery, giving a spark when its terminals are joined after a few minutes. If touching the terminals of a condenser across the B battery terminals causes a spark each time, when the operation is performed, say every second, the condenser is probably "leaking" and defective. The foregoing tests work out better with condensers of $\frac{1}{2}$ mfd. or larger.

Testing Audio Transformers

Hold the fingers of one hand so they touch the secondary terminals; momentarily connect a $22\frac{1}{2}$ volt B battery across the primary terminals of transformer. A distinct "shock" indicates both windings are probably good. This method is better than the test with phones in series with a dry cell, because even with an open transformer coil, the phones are so sensitive that a click will be registered when the circuit is closed.

A better method, especially where another transformer of the same type is available for comparison, is to test the winding in series with a high resistance voltmeter and a $22\frac{1}{2}$ volt B battery. A certain transformer, for example, in such a test shows a reading of 18 volts when the primary is in the circuit and of 8 volts when the secondary is under test. In other words, the resistance of each winding lowers the normal $22\frac{1}{2}$ volt reading obtained from the B battery.

Filling Panel Holes

Various preparations, such as "plastic wood" and "Houston's water putty," may be used to fill unwanted holes in panel material. Enamel paint to match panel will render the repair practically invisible.

The Ultimax Receiver

By C. W. Morris

THE kit type of five tube receiver consisting of two stages of tuned r. f. amplification, detector, and two stages of audio is well illustrated by the new Ultimax circuit, which is shown in the accompanying pictures. By the use of a three gang condenser, permitting single control, a set of inductance coils having a small external field, and a unique coupling arrangement for the r. f. transformers, an easily-assembled set having good selectivity and sensitivity is thus made available for the novice constructor.

By referring to Fig. 1, the schematic wiring diagram, the details of the r. f. stages can be more easily understood. The antenna tuned circuit is similar to most other 5 tube sets, with an aperiodic, or untuned antenna coil, wound in the same plane and on the same form as the secondary, which is of the basket weave type, of small outside diameter and more turns than the average inductance coils used in this type of circuit. The two r. f. transformers are identical in general design, so that the three tuning condensers, which are all mounted on the same shaft, will tune all three coils to the same frequency at any given setting of the condenser group, with only an initial adjustment of capacity in the trimmer or balancing condensers to take care of slight inaccuracies in the gang condensers.

As the r. f. transformers are of the auto-transformer type, the plate current of each r. f. tube is by-passed through an r. f. choke, and the radio frequency component in the plate circuit is passed through a .005 mfd. fixed condenser to the r. f. transformer primary. The two chokes and fixed condensers are mounted in a convenient sealed unit, with the necessary terminals along one edge of the case, for ease in wiring. By selecting the proper fixed condensers to go with the inductance coils, the r. f. amplifier has a remarkably flat fre-

quency characteristic through the broadcast band, and hence has uniform selectivity as well as freedom from oscillation.

In order to have the common terminal of each r. f. coil connected to the frame of the gang condenser, the grid of the detector has its return path through a 2 megohm leak directly to the positive filament, instead of being shunted across the grid condenser, as is usually the case. The r. f. amplifier filaments are controlled by means of a 10 ohm panel-mounted rheostat. An additional rheostat of 6 ohms controls the other tubes. To prevent overloading the filament of the detector tube, especially if it is of the gas filled type, a 4 ohm fixed resistance is inserted in the negative lead. Filament control for the power tube is obtained from a special 4 contact jack, so that when only one audio stage is wanted, the power tube filament is not in use.

The list of parts gives those used by the designers of the circuit and applies to the layout as shown in the pictures.

The panel and baseboard can be obtained already drilled, or it can be made up by using the drilling directions shown in Fig. 2. From the picture of the top view of the set, the location of the sockets, audio transformers, tuning condenser group and the binding posts can be seen. On the front panel are mounted the two filament rheostats, two trimmer condensers, filament switch, output jacks, and a vernier dial.

The three gang condenser is mounted on the sub-panel, which is lined up so that the condenser shaft projects through the hole in the center of the panel. The frame of the condenser unit has several holes drilled in it, and through these holes are passed machine screws secured by nuts underneath the sub-panel.

The three inductance coils are also mounted underneath by means of single machine screws, as shown in the picture of the sub-panel, with the Ultimax Unit placed in the center. The grid leak mounting and grid condenser are fastened in place, and a 4 ohm resistance

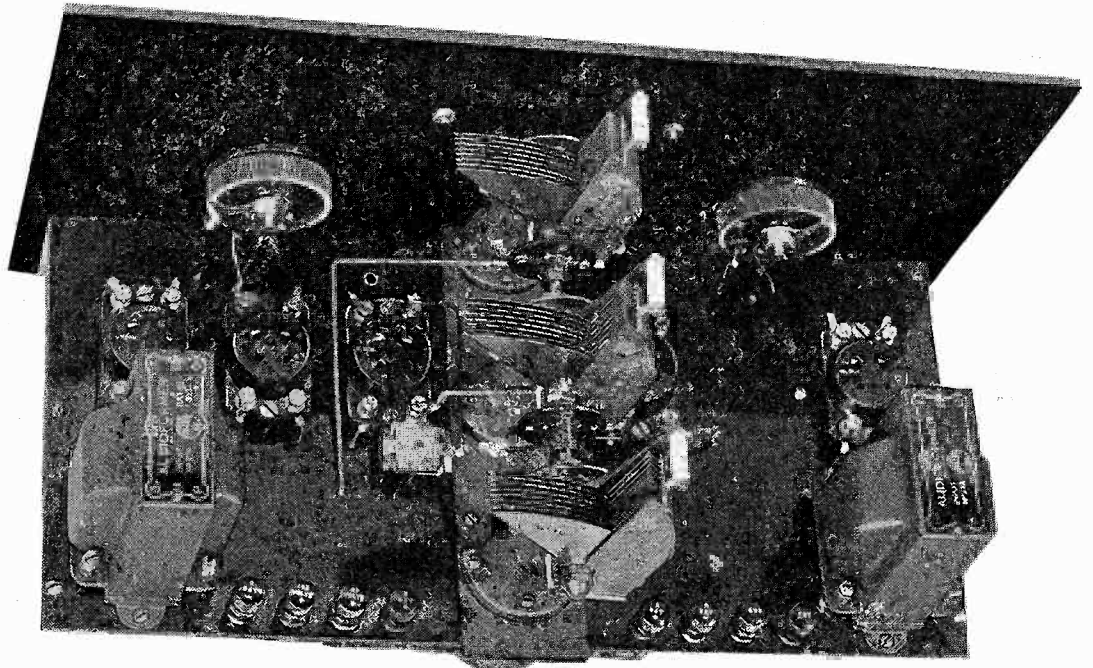

Rear Panel View of the Ultimax.

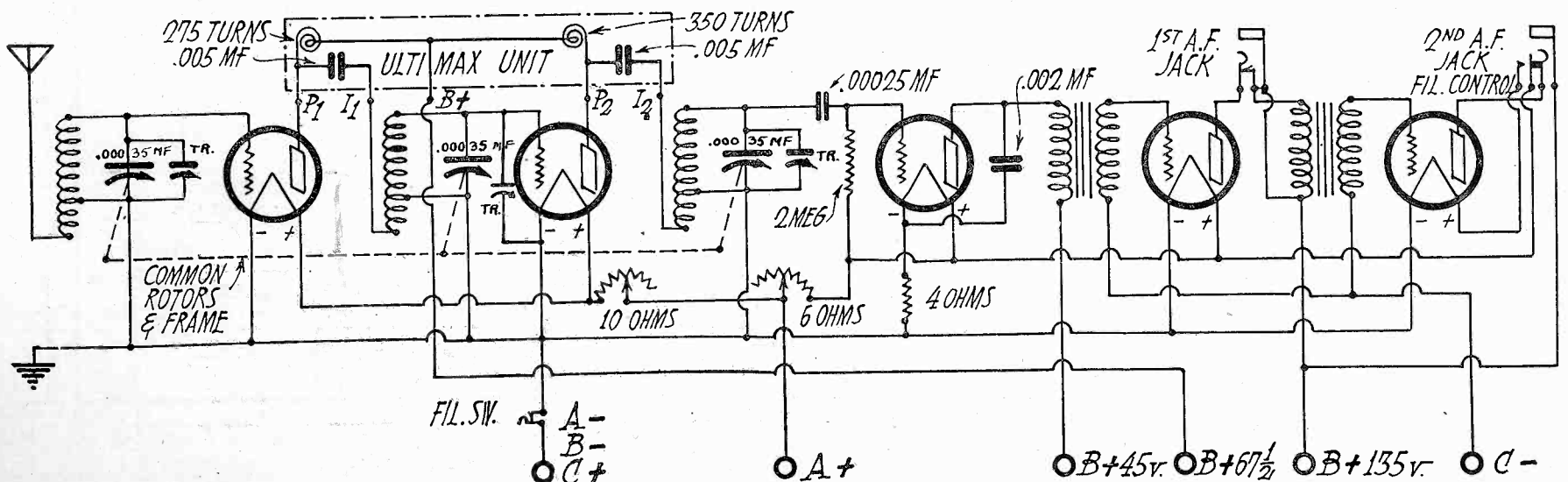

Fig. 1. Schematic Wiring Diagram of Ultimax.

strip for the detector is placed wherever there is sufficient room. Its position is not critical. The metal brackets holding the sub-panel to the front panel are placed underneath the sub-panel, with machine screws passed through the bracket holes. A bakelite rod with a hole drilled through the center to fit the 6-32 screw holding coil No. 2 to the

volts *C* battery. Should a larger sized power tube be needed in the last stage, a separate *C* battery lead from the *F* terminal of the second audio transformer will be needed to the larger sized *C* battery required by the power tube, using separate *B* lead from the frame of the output jack to the extra *B* voltage tap.

The 10 ohm rheostat controls the volume in the r.f. stages, and the 6 ohm rheostat, at the right of the tuning dial, after being adjusted to a point where good volume and quality is obtained in the loud speaker, need not be further adjusted except to compensate for changes in *A* battery voltage.

To adjust the tuned circuits, tune in a station around 400 meters, and bring the signal to its maximum peak by moving the tuning control back and forth past the setting for the station. Then move each trimmer condenser knob in turn, until the station is at maximum volume. It may be necessary to slightly re-adjust the main dial, but this trick can quickly be mastered. If the trimmer condensers do not reach a setting near their mid-scale, adjust the midget trimmer located on the 2nd r.f. tube socket, until the trimmer knobs both point to mid-scale, by screwing down the small set-screw located in the center of the condenser.

One feature of the Ultimax which is often overlooked in receiver design is that it will tune down to 180 meters, thereby insuring good tuning at the beginning of the broadcast band, at 200 meters, and continuing to the maximum wavelength of 570 meters, which is well above the top of the band. To serve as a guide for beginners, the following dial settings are taken as an average of a number of sets. 200 meters—25 degrees, 250 meters—47 degrees, 300 meters—60 degrees, 400 meters—79 degrees, 500 meters—91 degrees, 550 meters—96 degrees.

It will be found, often, that a loop receiving set will not work well in a stucco house. That is because the stucco walls are built up on a wire network for support. This wire network, which is grounded, acts as a grounded shield for the loop, or indoor aerial, which prevents good reception.

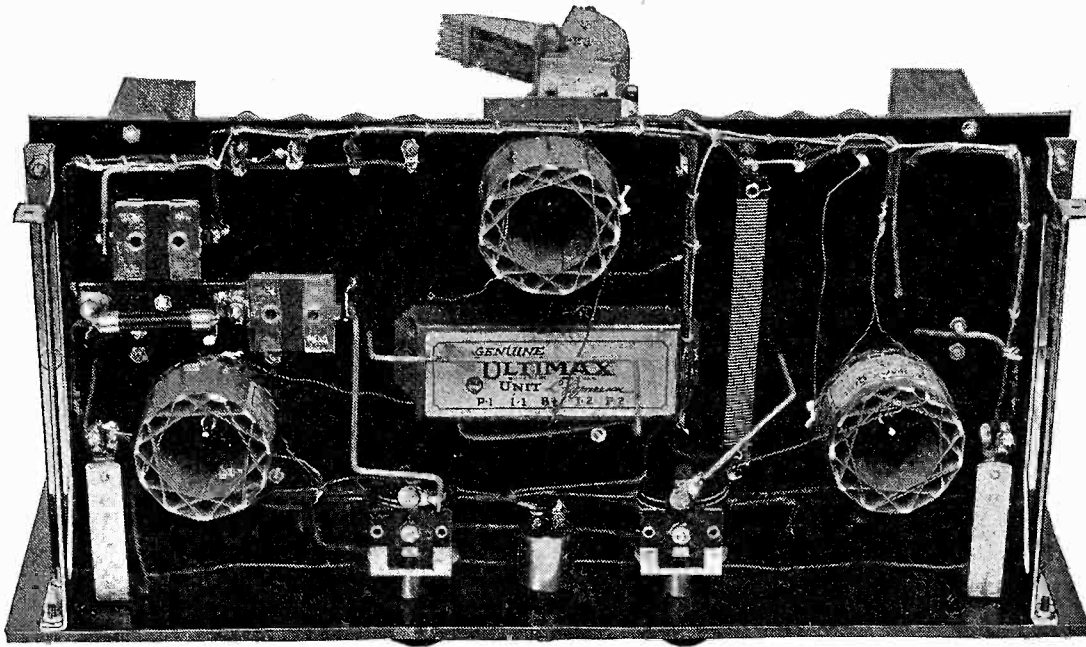

Apparatus Assembly Underneath Sub-panel.

sub-panel is used to keep the sub-panel from sagging.

In wiring the set, keep as much of the wiring as possible underneath the sub-panel, for the sake of appearances. The filament negative and positive, *C* battery, *B* battery positive, and grid return leads were all run with insulated wire, while for such leads as carried r.f. current, solid Celatsite was used. These wires which terminated at the binding posts, with the exception of the antenna, and at the jacks or other direct current terminals were cabled together with lacing twine, but this is optional with the builder.

The pictorial wiring diagram in Fig. 3 is the best guide to wiring, and also shows the location of the various tubes, which are not in a uniform order as is customary with such sets. In the factory made sub-panel, holes are drilled directly underneath the solder lugs on each socket, so that the wiring can be brought up through the sub-panel.

When the wiring is finished, make the usual tests for shorts or open circuits, by placing a tube in each of the sockets in turn, and touching the positive *A* battery lead to each binding post for both *B* and *C* batteries, with the negative *A* battery connected to its binding post. Should the filament of the tube light when the positive *A* wire is connected to any terminal except the positive *A* post, there is a short in the set, which must be located before connecting the *B* batteries.

The detector should have 45 volts plate, the two r.f. tubes require 67½ and the audio tubes 135 volts, with 9

LIST OF PARTS	
1	Set of 3 Ultimax Coils.
1	Pacent No. 3251-B three gang condenser.
2	Hammarlund Jr. Condensers Type MC-5—16 mmf.
1	Hammarlund Type EQ 50 Equalizer Condenser.
5	Pacent No. 83 Universal cushion sockets.
1	No. 62 Pacent Jack.
1	Ultimax Unit—(choke coils and condensers).
1	No. 95-A Pacent 6 ohm rheostat.
1	No. 95-B 10 ohm Pacent rheostat.
1	No. 62 Pacent Jack.
1	No. 65 Pacent Jack.
1	Kurz-Kasch Vernier dial No. 592—0-1000-1 black.
2	No. 27-A Pacent super audioformers.
1	Pacent No. 16 battery switch.
1	4 ohm resistance strip.
1	.002 mfd. Aerovox fixed condenser.
1	.00025 mfd. Aerovox fixed condenser.
1	2 megohm resistance—Aerovox.
1	No. 1 Electrad single grid leak mtg.
8	Eby binding posts, ensign type—Ant., Gd., A—, A plus, B det., 67 V, 135 V, —B, —C.
1	Panel 8½ x 16 x 3/16 Insuline.
1	Sub-panel 15 x 7 x 3/16 in.
2	Benjamin sub-panel brackets.
1	Special pillar post.

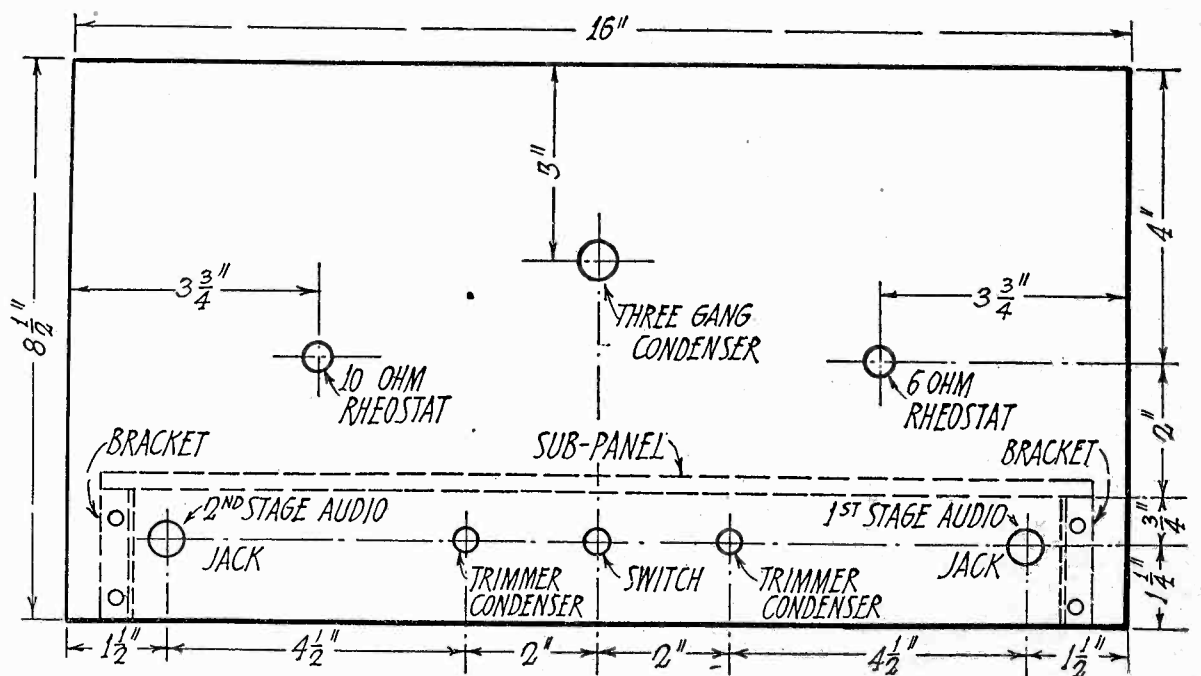

Fig. 2. Panel Drilling Dimensions.

Trickle Chargers

How They May be Used Without Damaging the Battery and How They May be Built

By G. M. Best

As the storage batteries will undoubtedly be used to supply filament current to vacuum tubes in radio receivers for many years to come, the problem of charging the battery is one that interests most radio enthusiasts. Radio batteries were originally charged intermittently from the a.c. power supply by means of rectifier handling from 2 to 6 amperes. Rather recently the practice has changed to the use of trickle chargers which deliver from .2 to .8 amperes continuously.

While the principles of trickle charging are well understood, many people do not know of certain limitations which may harm the battery if care is not used. The average radio set draws about 1½ amperes per hour. With six hours' use, this is 9 ampere hours. Due to various losses, a total of 11 ampere hours must be put into the battery to bring it back to its condition before use.

With 6 hours' use, 18 hours out of

24 remain in which to restore 11 ampere hours, which would be at the rate of 11÷18 or .6 amperes per hour. If the charging rate is below this amount, the battery will become lower in gravity from day to day until it is finally discharged completely. If the rate is slightly above .6 ampere, the battery will gradually become fully charged, and the slight excess charge will do no harm. This is why the fixed rate is .7 ampere, in most factory built trickle chargers, the rate having been worked out from the average case given above.

If the battery is not charged at a high enough rate, the plates will slowly become sulphated, and once the sulphation becomes permanent, the battery is dead and cannot be reclaimed. The action of the acid in the battery is to change the lead compound of the plates into lead sulphate. This sulphate, when newly formed, is readily changed back into its previous form, (lead and sulphuric acid) by charging the battery properly. But

if allowed to remain for some time it will become hard and cannot be removed except by constant charging and discharging at a high rate, over a period of days. Hence, if the trickle charger is not giving sufficient output to keep the battery up to normal, the internal structure of the plates will gradually become sulphated, and the daily charge will affect only the surface of the plates. This results in the battery testing O. K. as to voltage, but after a few hours use it will go dead without warning, and must be put through a number of cycles of charge and discharge before it will hold its charge.

The effect of trickle charging at too high a rate, especially with a small capacity battery, is to loosen up the material in the plates, and cause it to slough off, particularly on the positive plate. When the battery has become fully charged and the trickle charger is still left in service, the power fed into

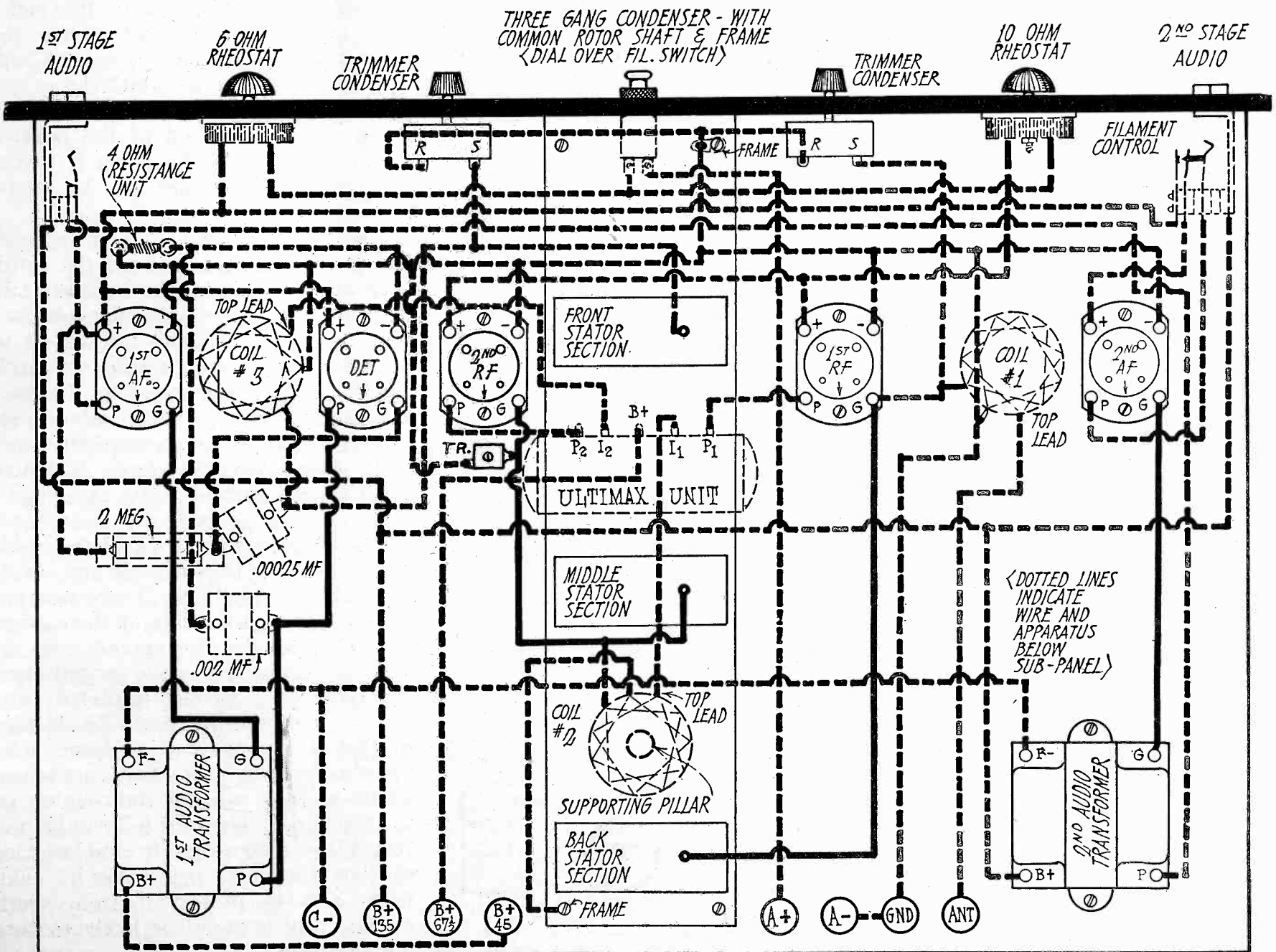

Fig. 3. Pictorial Wiring Diagram of Ultimax Receiver.

the battery is dissipated in the form of heat. This heat, being radiated over the relatively large surface of the battery, may not be evident to the touch. But if the battery is left in this condition over a period of weeks, as is often done, the plates will surely be damaged, when the charging rate is $\frac{3}{4}$ ampere, or anything near that value.

Therefore, it is advisable to disconnect the charger when the battery is to be left unused for a week or more, or at least to reduce the rate by inserting a mazda lamp in series with the primary of the transformer supplying the charger. An interesting table of charging rates furnished with the Balkite charger is given below, as a guide to the use of the lamp resistance.

Size of lamp in Watts	10	25	40	60	75	none
Amperes charge, for 4-volt battery	.1	.25	.40	.50	.60	.70

A simple method of placing the lamp in series with the primary is to use a Benjamin No. 92½ series cluster receptacle, in which the lamp is inserted, with the trickle charger connected to one side of the cluster, and the power circuit plug to the other side.

A charging rate of .1 to .25 amperes will not injure the battery in any way, as the charging power represented by that amount of current is too small to damage the plates, and yet is sufficient to keep the battery fully charged over a period of weeks of disuse.

If the receiving set draws more than 9 ampere hours per day, normal use, it will be necessary to take the battery to a service station every two or three months and have it charged at a higher rate until brought up to full charge. Or if the high rate attachment is already installed in the charger, as in the case of Fig. 2, the battery can be charged at the 2 ampere rate over night, or until the gravity reading is up to normal, which is 1270 for a battery in good condition.

Trickle chargers are divided into three groups: the electrolytic, including the aluminum-lead, and the tantalum cells, such as the Philco, Willard-colloid, and the Balkite; the bulb or gas filled tube type, such as the Tungar; and the contact types such as the Elkon or the Rectrox.

The schematic wiring diagram of an electrolytic charger is shown in Fig. 1. It consists of a step-down transformer, to reduce the 110 volt a.c. to a lower value, and at the same time provide safety by insulating the line from the

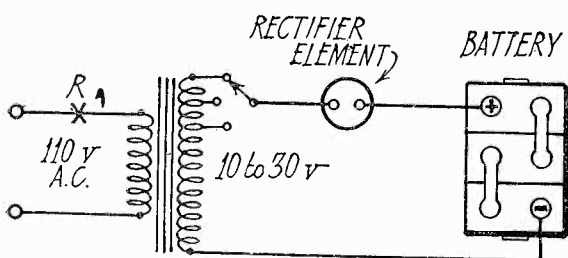

Fig. 1. Circuit Diagram of Electrolytic Charger.

rectifier circuit; a rectifier cell, and sometimes a resistance at the point marked *R* in the diagram, when the secondary of the transformer is not provided with taps for varying the charging rate.

In constructing a home made electrolytic charger the following material will be needed: 1 bell-ringing transformer, 50 watt size, 8, 16, 24 volt secondary taps; 1 one-quart Mason jar; 1 strip pure aluminum, $1 \times 5 \times \frac{1}{8}$ in.; 1 strip sheet lead, $1 \times 5 \times \frac{1}{8}$ in.; 1 porcelain base lamp socket with suitable sized mazda lamp. The lead and aluminum strips are bent at one end so that they will hang from the mouth of the jar, a hole being drilled in each strip and tapped for a machine screw so that connection to a soldering lug may be made. The strips are mounted one on each side of the jar, and the jar is then filled with a concentrated solution of borax, made by dissolving as much borax as possible in a quart of warm, distilled water. Over the surface of the solution pour a small quantity of lubricating oil. The aluminum element is connected to the positive *A* battery, and the lead element to the transformer.

To form the plates, short circuit the positive and negative output leads together for a few minutes, with the battery not connected. Then connect the battery and with a small range ammeter, measure the charging current for each of the three secondary voltages. If the smallest secondary voltage connection delivers more than .25 ampere to the battery, then a mazda lamp should be connected in series with the rectifier circuit to reduce the charging current to .1 ampere, for use when the battery is to be left idle for ten days or more. Probably a 10 watt lamp will be the right resistance for this purpose. If the maximum secondary voltage, with no resistance in the circuit, does not give $\frac{3}{4}$ ampere or better, then the rectifier cell has too high internal resistance, probably due to improperly formed plates, weak solution or chemically impure electrodes or salts used in making the solution.

The bulb type trickle charger will permit a higher charging rate than the customary trickle charger, when needed, so that current outputs from .2 to 2 amperes can be obtained with the proper designing of the transformer. The circuit diagram for a charger of this type is shown in Fig. 2, the apparatus consisting of a step-down transformer having two secondary windings (one of 2

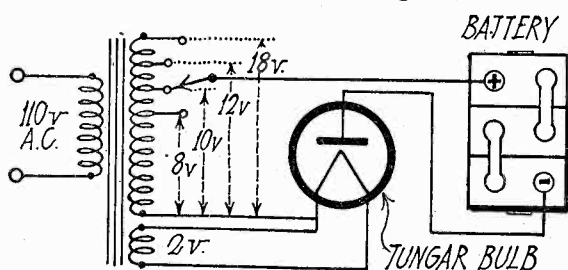

Fig. 2. Wiring for Tungar Bulb Charger.

volts for lighting the filament of the bulb and the other of 18 volts with taps for 8, 10 and 12 volts for variable charging rate), a No. 277,465 tungar bulb, and a porcelain mazda lamp socket for the bulb.

The details of a suitable power transformer are as follows, using a silicon steel core of good grade, built to the dimensions shown in Fig. 3. For the

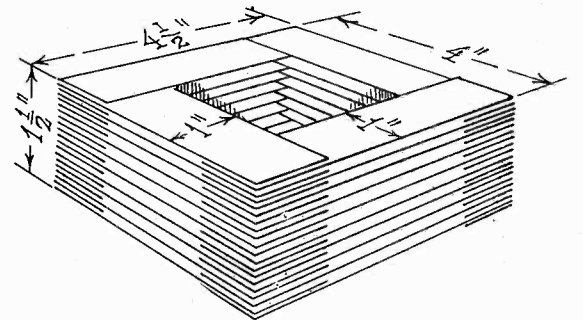

Fig. 3. Dimensions of Transformer Core.

primary, wind 550 turns of No. 20 D.C.C. wire, on one leg of the core. The filament winding should be wound on the opposite leg with 13 turns of No. 12 D.C.C. wire. The charging secondary should have 100 turns of No. 18 D.C.C. wire, with taps at the 44th, 55th and 66th turns, and may be wound over the filament secondary. The tungar bulb filament connections are made to the two terminals of the mazda lamp socket, and the plate connection is made by soldering a flexible wire to the metal shell located on the bulb above the screw base. The transformer and bulb can be mounted on a suitable base, and placed alongside the battery, with a metal clip on one end of the positive *A* battery lead, for fastening it to the taps on the secondary of the transformer.

Use the 8, 10 and 12 volt taps for the trickle charge rates, and the entire secondary winding for the 2 ampere rate when it is needed. Should the construction of a trickle charger not appeal to the reader, there are a number of excellent factory built chargers on the market, ranging from the inexpensive single rate chargers, to the more costly ones with several charging rates, including the 2 ampere rate for rapid charging.

The simplest way to shield the inside of a cabinet is to shellac it and, while the shellac is still "tacky," stick lead foil to it. The entire inside of the cabinet can be shielded in this manner, and the shielding connected to the ground binding post by a flexible insulated wire. The back of the panel can be shielded in the same way, cutting large holes for the binding posts and instrument shafts so they will not short-circuit on the shielding. The lead foil can be protected by shellacking it and sticking cardboard or heavy paper over it. This helps also to protect it from short-circuits, which would be likely to burn out the tubes.

"Those Bargain Sale Receivers"

By E. F. Kiernan

HARDLY a week goes by without a glaring full page, sometimes a double full page ad appearing in the daily "Bugle" reading somewhat as follows: "Gigantic reduction sale on 'Ether-Buster Radio Sets; the chance of a life time to secure a marvelous Ump-teen-Tube 'Squawk-O-Dyne' guaranteed to get Chilee, winter or summer. Positively not more than ten sets to a customer: line forms on the right: doors open at 5 a. m. and close at 10 p. m. sharp," and so on, et cetera.

That such an ad brings home the bacon, to the merchant, must be conceded, at least the frequent repetitions would so indicate. On the other hand, does the purchaser really get a bargain through discounts made possible by vast sales? The ads say so.

In the first place, can manufacturers of first class sets afford to knock the sales of their authorized dealers by allowing a large department or other store to sell several thousand receivers at a figure much lower than the advertised price? In general, they can't, so the coon must be under the coal pile.

A great many sets offered at apparently low prices may bear the name of a reliable builder; however, a '16 model flivver may have been a good car, in '16, not so in '27. Well, if you don't get this or that, let's see what you do get.

Receivers are generally sold either (a) without accessories, meaning, minus batteries, speaker, antenna equipment, etc., or (b) partially equipped, say with tubes and head phones, but no batteries, speaker, or antenna, or (c) complete, installed. Of course, "complete, installed," should mean that the purchaser plunks down just so much cash for the whole works, while on the other hand he may pay \$25 for a set and then find out that he must spend \$45 more before he can get a chirp out of his expenditure. At any rate, it is common sense to find out just what the price includes.

It's a mighty hard proposition to tell a novice how to pick out a good set. You can't tell him to look the rubber over, test the compression, try 'er on a steep hill, but there is one test he can make if he has two good ears; if he hasn't it won't make any difference anyhow. The test is simple, just listen. Now you can listen here, and you can listen there, but to hear anything you must listen in your own home; assuming that is where the set is to be installed. If you mean business, just have the set under consideration brought up and demonstrated at the house; any reputable dealer will gladly do this. Then if

your picket fence is out of phase with the garden hose, or the local power line parallels the antenna, the dealer will do his best to remedy the fault. Before, as well as after purchasing a receiver, consider the question of "service," or if you prefer, maintenance. There is no set on the market which is not subject to battery or tube replacements, possible short circuits, or accidental damage; so be prepared. Many installations are guaranteed for a year or more against faulty material or workmanship; at any rate it saves time, money, and much profanity to have an understanding with the dealer on the subject.

Now a word or two about some things to look out for in some of the older types of receivers which still "circulate" through the smaller cut rate stores. Lift up the lid on the nice shiny cabinet and glance inside. Are the terminals brought out to binding-posts mounted on a strip of good insulating material such as hard-rubber or bakelite, or are the posts fastened to a thinly stained wooden base-board? Wood is a good insulator provided it is bone dry, (it never is) while the stain is more than questionable. The least that can be said is that "it's cheap."

Now look around for some terminals marked C battery. If these terminals are absent you can be sure of two things; the output of the set will be poor in quality, while the tubes and especially the B batteries on multi-tube sets will need frequent replacement. Have a look at the sockets; will they take the newer tubes with the UX base or will you have to buy adapters?

The older and cheaper types of condensers have semi-circular plates with the rotor plates concentric on the shaft, and a plain dial. The newer types have eccentric rotor plates (or the equivalent) and a vernier dial. The eccentric plates are shaped so as to spread the location of the stations uniformly over the dial, while the vernier is simply a reduction gear to allow more accurate tuning. If you have a micrometer touch perhaps you can get along with the old stuff; most humans prefer the lazier way.

As for tubes, it simply doesn't pay to buy anything but A-1 stock. The tube is the heart of the radio and the few cents saved at the start will be spent a good many times over before the finish. A cheap tube may perform like a million dollars, for a while, but it soon loses its pep. Then you turn on more A battery to maintain the volume; pretty soon no A battery, no tube, and no music.

Since the arrival of the cone-speaker,

horns are going out, but a first class horn-speaker isn't to be sneezed at, in fact is preferable with sets using 199 type tubes. In short, it takes power to make a cone step out, and the small tubes can't deliver the goods. Another point, a good horn can be picked up for about one-third the price of an A-1 cone.

In conclusion it might be well to bear this in mind, the local authorized dealer is a business man; to remain in business he must not only sell his goods but must keep them sold. He expects to get repeat orders on accessories, parts, service, etc., hence he aims to satisfy. Nuff Sed?

R. F. RESISTANCE OF COILS

The resistance of wire is well known to be greater at high frequencies than at low. As the standard tables of the resistance of copper wire are for direct current (zero frequency), any accurate determination of their resistance at radio frequencies requires a correction factor. As no dependable formula has yet been developed to evaluate this factor, reliance is usually placed upon actual measurements.

A number of such measurements as made by E. L. Hall are published in Technologic Paper No. 330 from the U. S. Bureau of Standards. This gives the resistance of various sizes of wires at frequencies from 150 to 2000 k.c. when wound on three inductance coils. Measurements between 150 and 911 k.c. were made with 61 and 68 turns wound on coils 6 $\frac{1}{8}$ in. in diameter and between 911 and 600 k.c. with 8 turns in a 4 $\frac{1}{8}$ in. coil.

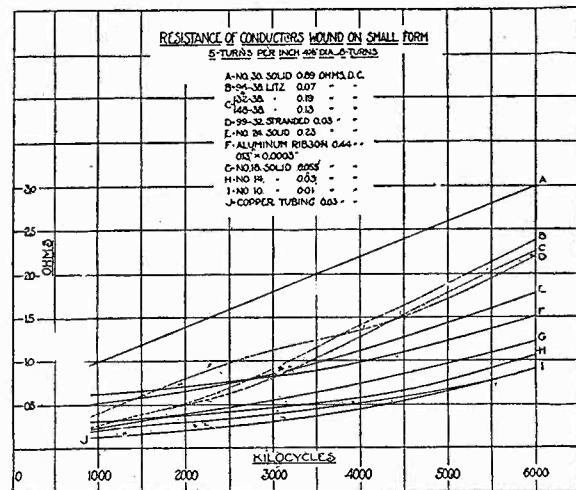

Fig. 1. Increase In Resistance With Frequency.

As the latter is more nearly in accord with common radio requirements the results of the author's measurements are here shown in Fig. 1.

His general conclusions are that litz wire with a large number of strands is best for frequencies from 150 to 1500 k.c., No. 14 or No. 18 being second choice. Litz should not be used above 1500 k.c. (below 200 meters) if low coil resistance is desired.



QUERIES *and* REPLIES



Questions of general interest are published in this department. Questions should be brief, typewritten, or in ink, written on one side of the paper, and should state whether the answer is to be published or personally acknowledged. Where personal answer is desired, a fee of 25c per question, including diagrams, should be sent. If questions require special work, or diagrams, particularly those of factory-built receivers, an extra charge will be made, and correspondents will be notified of the amount of this charge before answer is made.

I have a Bremer Tully Counterphase Six, and would like to know what difference there is between this set and the Counterphase Eight. Please publish a diagram of the Eight, with a description of the circuit.—R. J. T., Dayton, O.

The Counterphase Eight is a factory built set, similar in circuit to the Counterphase Power Six described in December 1926 RADIO, except that the r.f. stages are shielded and a third audio stage is added. The circuit diagram is shown in Fig. 1, and on the diagram are indicated the values of the various parts. The shields are shown by dotted lines. A switch is connected in the audio circuit so that one of the audio stages can be cut out when not needed. In the antenna circuit a special rejector coil is connected, so as to increase the selectivity. The filament circuit of each r.f. tube is equipped with r.f. chokes to prevent r.f. currents from entering the various amplifier circuits through the filament wiring.

Will the "A" battery eliminator described by G. M. Best in January RADIO function as an "A" battery charger?—W. B. C., Berkeley, Calif.

The outfit can be used as a battery charger with excellent results. Due to the use of a full wave rectifier, it can be floated across the storage battery without any hum being heard in the receiver. The storage battery makes a fine electrolytic condenser, so that the condensers or resistances specified for the "A" eliminator alone would not be needed if the battery is permanently connected across the line.

Please give me a diagram of the "N" circuit as set forth by Sir Oliver Lodge. Also please give the specifications for winding the coils.—P. J. F., Etna, Calif.

There are as many versions of the "N" circuit as there are letters in the alphabet. The one which has received the most publicity is shown in Fig. 2. It was originally published in an English radio magazine, and hence can be considered as authentic as any of the "N"

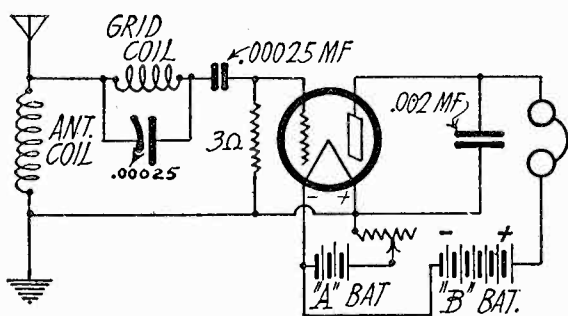

Fig. 2. The Lodge "N" Circuit

circuit combinations shown in this country. Tuning is accomplished by the variable condenser shunted across the coil in the grid circuit. The inductance, to tune through the American broadcast band, should have 65 turns of No. 22 silk covered wire wound on a 3 in. tube, with .00025 mfd. variable condenser. The antenna coil consists of 70 turns of No. 22 wire on a 3 in. tube, and should be placed at some distance from the grid coil, so as not to be inductively coupled. The English version of the circuit shows the plate grounded, which is a doubtful expedient, so that Fig. 2 shows the ground at the negative end of the filament circuit.

Kindly furnish data for the construction of a two-ampere battery charger using tungar bulbs.—H. J. C., Big Creek, Calif.

See the article on the "A" battery eliminator by G. M. Best in January 1927 RADIO. Complete data for winding the transformer are given.

Have built the eight-tube Best Superheterodyne described in January 1925 RADIO, and have the following questions about it: Would shielding this set cut out noise from local electrical machinery? Will it lessen the efficiency of the intermediate transformers to mount them on the shield? Should the oscillator, frequency changer and intermediate amplifier be shielded from each other? Should the shields for the inside of the cabinet be all connected together, or left floating?—L. E. B., Taft, Calif.

Shielding the inside of the cabinet with sheet brass or copper will cut down interference from local stations to a certain extent, but if you are bothered with noise from electric power apparatus, the noise must be eliminated at its source, as the interference is radio frequency and comes into your set through the loop antenna more than into the wiring of the set. The Remler transformers have an open iron core, and must not be mounted nearer than 1 in. from the shield, or their peak frequency will be thrown off to such an extent that each oscillator dial setting will have two distinct peaks, with resulting loss of selectivity and distance. It is an excellent idea to shield the oscillator and frequency changer from each other, and from the intermediate amplifier. A handy way to do this is to follow the general design of the 1927 model superheterodyne described in Feb. RADIO, insofar as the method of shielding is concerned. The cabinet, if lined with shielding, should have all shields connected together and to the negative "A" battery terminal, which in turn should be grounded.

Please advise as to the simplest form of chemical with which to make the solution for an electrolytic battery charger, using aluminum electrodes.—H. P. B., Stockton, Calif.

Common borax is an excellent base for the solution, which should be made by dissolving as much borax as is possible in warm, distilled water. After the solution has cooled from contact with the jars in which it is placed, some of the borax will crystallize out and be deposited on the bottom of the jar, so that the solution will always remain concentrated when the room temperature changes, or the rectifier becomes hot due to excessive load. Cover the top of the solution with a thin layer of lubricating oil, to prevent undue evaporation.

Have a 45,000 cycle superheterodyne with type 99 tubes, which after operating satisfactorily for some time, became unstable, oscillating and squealing so

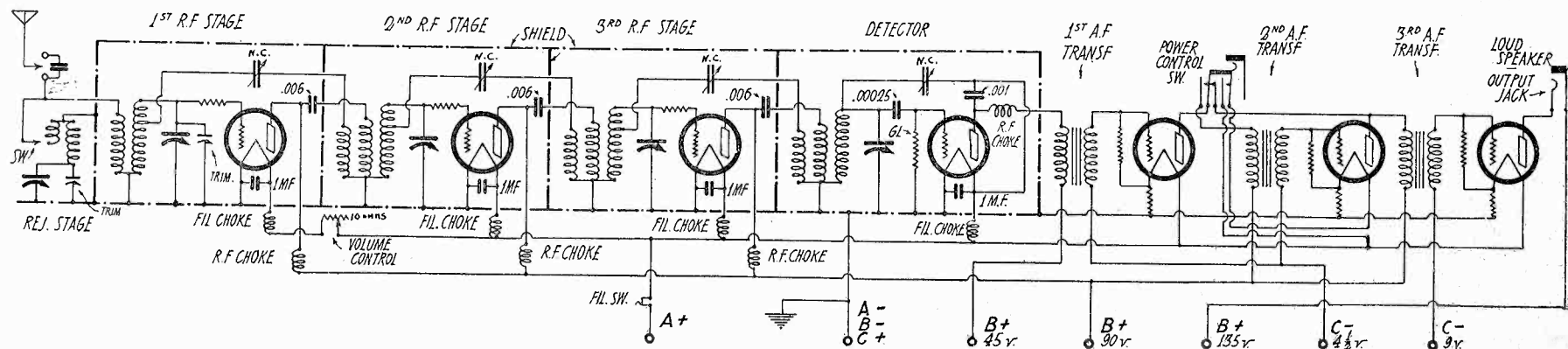

Fig. 1. Circuit of Counterphase Eight.

that reception is very poor. The batteries, tubes and midget condenser have all been replaced. What could be the trouble?—B. F. T., Minneapolis, Minn.

Since you have checked over the batteries and tubes, the trouble must be in the intermediate amplifier or 1st detector. A loose core in one of the intermediates, or a defective transformer will cause oscillation, and it might be that the filter condenser has become leaky due to moisture. Remove the intermediate transformers and shake them vigorously. If any of them rattle, the coil assembly has become unfastened from the frame, and the transformer should be returned to the manufacturer for repairs.

Have a Kennedy four-tube regenerative receiver with three stages of audio. Would like to add two stages of tuned r.f. to this set, retaining the regenerative feature. Please give me the necessary data to accomplish this.—E. B., Newman, Calif.

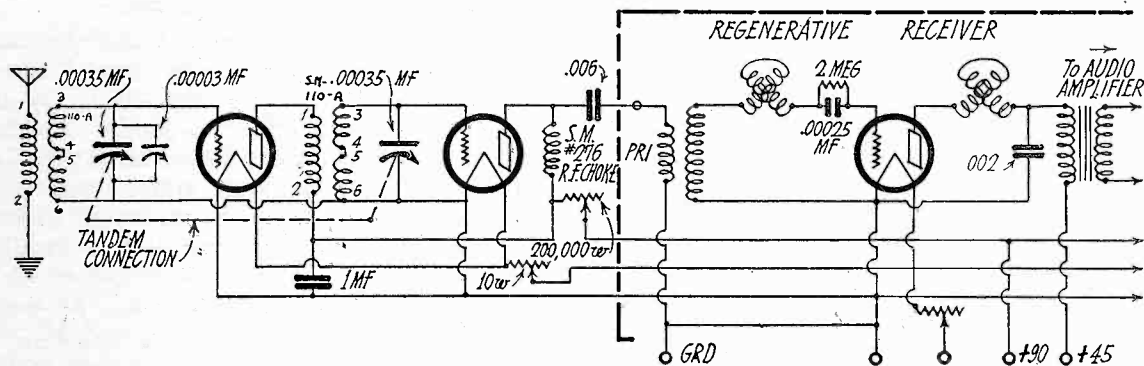

Fig. 3. Adding Two Stages of Tuned R.F. to Regenerative Set.

In Fig. 3 is shown a two-stage r.f. amplifier which has been used in connection with various detector and audio combinations in our laboratory. It has been modified so as to be adapted to the Kennedy receiver. The antenna and r.f. transformer coils are both Silver Marshall type 110-A, and the terminal connections are shown in the diagram. The two tuning condensers are in tandem, and a trimmer condenser should be shunted across the first coil, to take care of the effect of the antenna on the secondary winding. The laboratory type amplifier consisted of two stage-shields such as are used in the Silver Shielded Six, with the antenna coil, 1st r.f. tube and by-pass condenser mounted in the first metal shield, and the r.f. transformer, output choke, and 2nd r.f. tube mounted in the second shielded can. The output of the second r.f. tube is fed into the detector by means of impedance coupling, using the old primary of the tuner for the plate coupling coil. The amplification of the r.f. stages is controlled by a 200,000 ohm variable resistance, but the filament rheostat can also be used if the plate control seems too critical.

I have a five-tube superheterodyne using crystal detectors, as described in RADIO for April, 1926. The volume control rheostat functions only in the first quarter of its swing, no change in volume taking place during the rest of the dial settings. Have found no fixed condenser which suits the filter transformer. What would you suggest?—I. R. A., Chicago, Ill.

To spread the control of volume over the entire dial will require the installation of a tapered resistance, which is so designed that the resistance decreases according to a logarithmic formula, as the dial is turned toward the zero setting, from maximum. Such resistances can now be obtained in values ranging from 50,000 to 500,000 ohms. If the two settings of your oscillator dial cannot be

made sharp, especially on local stations, your filter may be defective, since you have tried several condensers across the secondary and found none of them satisfactory. In such crowded sections of the country as Chicago, the filter must be very sharp to give good selectivity, and it is often necessary to install two filters matched to exactly the same frequency to cut through the powerful local stations.

Kindly give me data for improving my last year's Best Superheterodyne, with adapter for the antenna instead of the loop.—G. G. M., Owatonna, Minn.

See the article on the 1927 model in Feb. RADIO. You can add the tuned r.f. stage ahead of the first detector without having to rebuild the set by constructing the amplifier in a separate cabinet, and connecting the output of the r.f. transformer to the loop terminals of the present set. This method will permit greater selectivity, and will greatly

reduce the trouble due to oscillator harmonics.

Please advise how to add another stage of r.f. amplification without adding another condenser or transformer. I understand several factory built sets use this system.—A. H. D., Denver, Iowa.

A circuit for installing an extra r.f. stage ahead of a standard five-tube re-

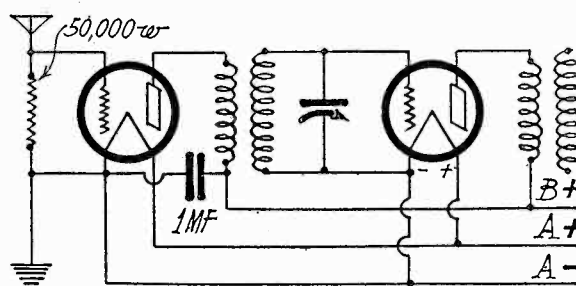

Fig. 4. Untuned R.F. Amplifier for Five-Tube Receiver.

ceiver is shown in Fig. 4. This method is used in a number of six-tube tuned r.f. receivers, to permit single control of the three r.f. transformers without the use of trimmer condensers, necessitated by the effect of the antenna, which changes the tuning of the secondary, of the first r.f. transformer. Due to the presence of the high resistance in the antenna circuit, this tube will just about compensate for the loss due to the high resistance, and hence no appreciable amplification over that obtainable with the five-tube arrangement will be had.

I have a Sargent-Rayment infradyne which is giving satisfactory results, but the four knobs on the infradyne amplifier unit have to be adjusted a considerable distance from the zero mark, the right hand knob next to the detector tube being way off the scale. Is it customary with the amplifier, or is it defective?—G. A. L., Kahului, T. H.

The knobs are adjusted to zero with a standard set of tubes, at the factory, but as tubes vary considerably in the value of the inter-electrode capacity, the set-

tings of the knobs will hardly ever fall exactly on the zero setting. This is especially true of the knob controlling the last r.f. transformer, at the right hand end of the amplifier, looking at the set from the front, and as long as a resonant point can be located when moving the knob back and forth with the wooden adjusting lever, the amplifier is O. K.

BOOK REVIEWS

"Principles of Modern Radio Receiving," by L. Grant Hector, 300 pp. 5½x9; Burton Publishing Co., Buffalo, N. Y. Price \$5.00.

This text is essentially the manuscript of a semi-popular lecture course which the author has given at the University of Buffalo, where he is assistant professor of physics. After an introduction to the subject of wave motion as based on sound, the author devotes three chapters to a discussion of electrical conduction, induction and capacitance. These fundamental principles are then applied to an analysis of the action of vacuum tubes and associated apparatus in the detection and amplification of energy at audio and radio frequencies. Circuit diagrams of most of the standard types of receivers are shown and discussed. The concluding chapter discusses the theory of battery chargers and battery eliminators. A layman could follow the treatment by skipping the more technical portions. A technical man could learn more by reading some of the books listed in the bibliography. In the reviewer's opinion, it would be a difficult text for home study without the benefit of class contact.

"Radio Encyclopedia," by S. Gernsback; 168 pp., 8½x12. Published by the author, New York City. Price \$2.00.

This comprehensive volume defines terms and illustrates and describes equipment used in radio transmission and reception. The convenient alphabetical arrangement of items is supplemented by a classified index of co-related subjects. It is valuable not only as a reference book but also as a condensed text for home study. Many readers will recognize it as a reprint of a long series which was published in *Radio Review*.

"The Radio Amateurs' Handbook," by F. E. Handy, 176 pages, 6½x9½, paper bound, published by The American Radio Relay League, Hartford, Conn.; price \$1.00.

This is an intelligent compilation of facts about short-wave radio telegraphic communication. Much of the information, having previously been published in *QST*, has been tested in the fire of possible criticism and may now be accepted as reliable. The book consists of eight chapters and an appendix. They deal respectively with the definition of an amateur, getting started, fundamental electrical theory, an explanation of the theory of radio transmission and reception, directions for building and operating a station, a description of the A. R. R. L. communications department, and data for the experimenter. Full directions are given on how to learn the code and how to read circuit diagrams. The procedure in securing an amateur license is described and an understanding of all the information given in this book should enable anyone to pass the necessary examination. The entire book should prove of great interest and value to the amateur radio operator, present or prospective.

NEW RADIO CATALOGS

"Carborundum in Radio" is a hook-up book from the Carborundum Company, Niagara Falls, N. Y. After illustrating and explaining the electrical characteristics of carborundum detectors, pictorial and circuit diagrams are given for its use in various types of receivers. Other radio applications of carborundum are also shown.

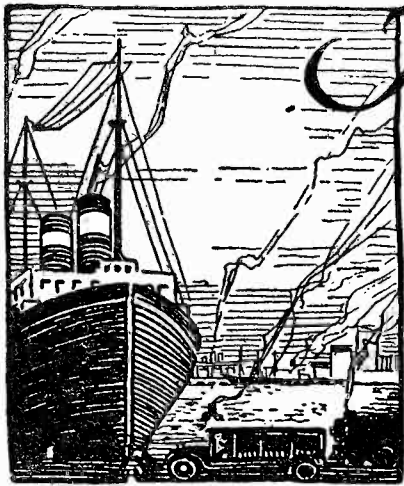

The COMMERCIAL BRASSPOUNDER

A Department
for the Operator
at Sea and Ashore



R. O. KOCH, *Great Lakes Correspondent*

Edited by P. S. LUCAS

C. W. RADOS, *Boston Correspondent*

LET'S MAKE AN EFFORT

Among the wireless operator's many duties aboard ship, he is sometimes uncertain as to just what is most important and should receive the first consideration. With the exception of distress calls and the necessity of medical aid, which are very infrequent occurrences, he has a list of different little jobs which require his attention off and on all during the day. Nearly all ships handle a little traffic, and send in a nightly TR. When on the coast, bearings are sometimes needed, weather and hydrographic reports and the time tick are always in demand. When on deep water, time, weather, hydrographic reports and press are expected.

If a man tries to get everything that is broadcast from the many stations during the course of twenty-four hours, he will never get rid of his TR or msg. Nor would he ever get any sleep. (Refer to our schedules in RADIO and see.) The thing to do, then, is decide what must come first, second and third and arrange a schedule with the Ingersoll.

It is generally conceded that at least six hours a day should be spent logging 600, 706, 2100 and 2400 meter stations, or whatever working wave you use. This is important in case somebody has some traffic for you. If he has, you will certainly be doing your bit to keep the ether clear by taking it away from him. It is also important in case some ship should decide to pull the plugs out of her bottom.

Being scheduled for six hours a day on ship waves, leaves only two hours of a working man's day in which to copy at least one page of press, a couple of weather reports, get a time tick, etc., which usually take more time than one would figure on. Therefore, if you want your "Scandal Sheet" to be interesting, and if you try to give the bridge gang a little more than they expect, you must either cut the ship watch a little short, or lengthen your hours. And I think quite a majority of the gang take the latter course. Those who do almost invariably get the reputation of being good operators; those who are afraid to spend a little extra time also establish for themselves a reputation. And that reputation makes itself felt over the whole fraternity.

The old adage "If a thing is worth doing, it is worth doing well," applies perfectly to Sparks' job on a ship. If we, as a group of brasspounders want to make this profession a decent one; a profession of dignity; we each must make an effort to do a little more than is required of us. If we do, it will not be long before the steamship companies, or whoever hires us, will come to the realization that when they sign on a radio operator they are signing on a licensed officer, entitled to the same amount and type of respect as that given any other officer.

In spite of all the ideas some of us have about what the profession needs to make it what it ought to be, I think we'll all agree that if we as wireless operators could command the respect of those to whom we are responsible,

we should be treated justly and be given what we now think we should have without asking. The trouble is that it is hard to establish such a reputation when a few operators will invariably, by their indifference to the efforts of their fellow operators, carelessly tear it all down in one trip.

The only remedy seems to be education. A few wise words to the student, intended to create the proper attitude, might turn the trick. A much more difficult examination might make a man appreciate the dignity attached to his ticket. Quien sabe?

W. D. M.

By C. O. SLYFIELD, *Radio Supervisor Ann Arbor Railroad Co.*

On November 24, 1926, a new radio station, owned and operated by the Ann Arbor Railroad Company, went into commission at Menominee, Michigan, with the call WDM, which will bring back fond memories to many of the old-timers. To those who were not operating ten years ago it may be interesting to know that this call was formerly assigned to the Marconi Wireless Telegraph Company's pioneer radio station at Duluth, Minnesota. In those days WDM was poking out wicked signals on a 25 cycle straight gap and later on a non-synchronous rotary. O. R. Redfern was chief operator of Lake Superior and worked first trick at WDM most of the time in those days. He had one of the prettiest mitts to which it has been my pleasure to listen and made that call one of the most familiar on the Lakes. By the way, Mr. Redfern is now U. S. Supervisor of Radio for the Seventh District, with offices at Seattle, Washington.

This call, which made radio history on Lake Superior, is again becoming more familiar to the fraternity of commercial operators, and when navigation opens on the Great Lakes again in the spring, its reputation should be well established. The prime purpose of this station is to handle point-to-point railroad traffic with similar stations at Frankfort, Michigan, Manistique, Michigan, and Manitowoc, Wisconsin, and the five car-ferries of the Ann Arbor Railroad Company plying the year around on Lake Michigan. This station maintains both PG and Limited Commercial licenses; the PG service being handled on 715 and 875 meters and the point-to-point service on 1666 meters.

The station equipment consists of an R.C.A. type ET-3634 master oscillator-power amplifier transmitter employing one UV-211 as the master oscillator and four UV-211's as power amplifiers. This transmitter has a continuously variable wavelength from 600 to 2500 meters. The master oscillator variometer is calibrated for the various wavelengths, the antenna being resonated by means of a second variometer, the combination of which provides the continuously variable wavelength.

The receiving equipment consists of an IP-501 receiver, covering wavelengths from 250 to 8000 meters, combined with a triode two-

stage audio amplifier. The receiver is entirely shielded; that is, the panel is shielded and the cabinet is lined with metal and a shield placed between the primary and secondary coils. This is a beautiful job and should bring joy to the heart of any radio operator.

The aerial, which consists of one wire 200 ft. in length, is supported by two Western cedar poles 87½ ft. long, set 10 ft. in the ground, giving an effective height of 77½ ft. The ground consists of three heavy copper plates, 3 by 9 ft., securely riveted and soldered together and buried 7 ft. under ground in water. (We are very sure of this fact because Mac and I dug the hole ourselves.)

The station is located at the foot of Sheridan Road, the main stem of Menominee, in the new Ann Arbor office building, which was completed just prior to the installation. Two rooms of this building are provided for radio purposes, one for the motor-generator and battery and the other for the transmitter panel, receiving equipment, desk and so forth. The building is well lighted, there being three large windows in the two radio rooms and is heated by means of an Arcola hot water plant.

WDM is in the charge of Mr. Ferris McKesson, familiarly known as "Mac," SOS hero of WDO, and for the past three years second trick operator at WFK. Mac has a beautiful fist and sends equally well on a bug which makes it a pleasure to listen to WDM batting off messages with such perfect precision.

ORIENTAL RADIO NOTES

By MICKEY DORAN

1. Following QST sent by VPS on December 2, 1926.

"QST—Commencing from 1600 GMT December 4, 1926, and until further notice, the 600 meter (weather) service for ships at sea will be taken over by the Royal Observatory Hong Kong. Until other Call Letters are allotted, the call sign VPS will be used. The transmitter installed at the Observatory is of the valve type and will use ICW, sharply tuned. VPS." This refers to the 600 meter weather bulletins previously broadcast by VPS on spark at 0400 and 1200 GMT.

2. KZRQ, the coastal station at Manila, P. I., is transmitting on 675 meters only; calling, answering calls and handling traffic on this wave instead of the 600 meter wave formerly used. KZRQ advises that their coast charge on U. S. Shipping Board business traffic (Govt. SB) is now six cents U. S. currency per word. The six-cent rate also applies to traffic from Inter-Island vessels, but all others must pay ten cents.

3. The Weather-Traffic-Press schedule sent out by WNU, New Orleans, can be copied easily anywhere in the North Pacific east of the 180th Meridian. This is the schedule sent at -430 GMT on 3331 CW. With luck it can be carried a thousand miles beyond the 180th.

ADD THESE TO YOUR SKEDS

From STANLEY WADE, S.S. *San Gil*

WBF, Boston, besides his regular 600 meter watch, listens for CW ships on 2100 meters from 35 to 40 minutes after each hour. Answers on 600, 690, 2100 or 2350, CW or ICW.

UB, Almirante, Panama. Has ship schedules on 600 at 6:45, 8:00, 10:15 and 12 a. m.; 1:00, 4:00, 6:00, 8:00 and 9:30 p. m., 90th Meridian Time. Answers on 600 ICW, but is prepared to QSY to CW, or 2100 CW, ICW, or to high power CW on 4075 meters. All traffic is relayed direct through WNU. UB also sends wx for East and West Gulfs, Caribbean Sea and Windward Passage on 4075 CW at 10:45 a. m. and p. m. C.S.T.

WAX and WNU have returned to their former px sked. WAX sends private px to KUS at 6:30 a. m on 5554 CW. WNU sends private px at 11:30 a. m. and p. m. on 3331 CW. Both 75th Meridian Time.

COLD WX ON GREAT LAKES

By R. O. KOCH

Just about the time that most of the ops on the Great Lakes were preparing to sign-off for the season, the weather man seemed to think that their fists should have a good limbering-up before going into winter ordinary. The temperature dropped—heavy snow fell, and 121 huge freighters were trapped in the St. Mary's River! For miles and miles they were strung out, single file. And then came the call for radio to do it stuff. VBB should really be telling about this, but he is still busy with the remaining ships, so can't be bothered with such trivial matters.

Fortunately, a great many of these freighters are radio-equipped, and any op in the vicinity of the Soo for the past few weeks will tell you that San Francisco QRM is mild compared with this. VBB is right on the Canadian side of the Soo and almost within speaking distance of the trapped vessels. A few of the ops forgot to remove the tubes from their receiving sets, with a very tragic consequence. They tell us that every time VBB touched the key of his little (?) 4 K.W. tube transmitter one could see a shower of receiving tubes come through the roofs of the various radio shacks. Will some op please send us a picture of this?

Now to get back to the ice. The huge car-ferry *Sainte Marie* was sent to the aid of the stranded vessels, and she really made things move, although rather slowly. She is of the ice-crushing type, having her propellers fore instead of aft. When she tackles ice, something just has to move. Unfortunately, she is not radio equipped. Her regular run is across the Straits of Mackinac between the ports of Mackinaw City and St. Ignace, Michigan. These two cities are only a few miles apart, but there is real "he" ice in this narrow stretch of water. On her regular run, she would have no use for radio equipment. Had she been radio equipped she would certainly have handled some traffic. As it was, all messages for this ship were sent to nearby vessels who delivered the messages by carrying them over to the *Sainte Marie*.

With the assistance of tugs and favorable weather, a number of vessels have been released, and it is hoped that the Storm God will show a little courtesy so that the balance may be freed. Should a sudden cold spell set in, these ships would have to remain in their present positions until the spring thaw. The upbound ones are mostly loaded with coal, while the downbound ones mostly have cargoes of ore. Those who are coal-laden don't have to worry about running out of fuel at least.

So far two lives have been lost. Two sailors wandered off one of the Canadian vessels

and fell through some slush ice and drowned.

We are sorry that we do not have the names of the operators who did most of the work in connection with this blockade, but the boys at VBB certainly did their share of it. WBS also did some nice traffic handling with that new tube set of his. We wish that our old ice-breaking friend, WDP, had gone up there to help open the channel, but she has other channels to keep open.

Coincident with the blockade at Sault Ste. Marie, the S.S. *J. L. Reiss* sank right across the breakwaters at Sheboygan, Wisconsin, with a cargo of 9000 tons of coal. She hit the south pier when trying to enter the port in a big storm. She is but a few blocks away from coastal station WSK, which is operated by the Reiss Company. The harbor is completely closed off by the stranded vessel. She will be raised and taken to Manitowoc for repairs.

LET'S TALK ABOUT RADIO LAWS

By RAWSON B. DIXSON

A revision of the radio communication laws of the United States will eventually be considered by Congress—if not at the present session, surely at the next—and it seems that commercial operators should be sufficiently interested to make some effort to have their interests considered before any new legislation is passed. The B. C. L.'s, the amateurs, manufacturers and steamship companies have their representatives in Washington, so why don't commercial operators do the same?

If commercial operators can form some sort of an organization and agree on a program, they can send one of their members to Washington to represent them. If they cannot do this, they can at least agree on the main features of a definite program, through these columns, and write to their senators and representatives, urging its adoption. If enough operators will take the trouble to write, I believe their opinions will receive consideration.

I am appending a list of suggestions for changes in our radio communication laws that I believe desirable, and I should like to know the opinions of other operators, as well as the opinions of supervisors of radio. Following are my suggestions:

CLASSIFICATION OF VESSELS

First Class: Paragraph 18, Part II, *Regulations Governing Ship and Land Stations*, "Radio Communication Laws of the United States," might remain as at present, except that vessels now in the second class (see Par. 19) should be placed in the first class. So far as I know, no American vessel carrying more than one operator maintains anything but continuous service.

Second Class: This should include all vessels, not placed in the first class, of 1500 tons or more net register, who go a distance of 300 or more nautical miles between ports.

Third Class: Voluntarily equipped vessels.

GRADES OF OPERATORS REQUIRED

First Class: Vessels of this class should be required to maintain continuous service with three operators, the senior of whom shall hold a commercial first grade or higher license, the next in seniority a commercial second grade or higher license, and the junior operator a third grade commercial license or higher. *Provided*, that the voyage of the vessel requires 60 hours or more between ports. Vessels at sea less than 60 hours might be permitted to maintain continuous service with two operators, holding, respectively, first and second grade commercial licenses or higher.

This would exempt most of our coastwise passenger vessels from carrying three operators, at the same time requiring those vessels on trans-oceanic or other long voyages to maintain continuous service with three operators.

There should be no objection to this. Eight hours is generally considered a day's work, both ashore and afloat. Operators standing watch and watch on long voyages do not get sufficient sleep, if they stand their watch conscientiously. On two-operator ships making long voyages the operators frequently yield to the temptation to sleep on watch, and, in general, maintain only an indifferent watch.

Second Class: Vessels of this class should be required to carry one operator holding a second grade

or higher license. *Provided* that where an operator holding a second or first grade license is not available, the United States Supervisor of Radio, or the collector of customs, in ports where no supervisor is located, may authorize the employment of an operator holding a third grade commercial license, such authorization to be valid for one voyage only. Vessels of the second class should maintain watch on ship wave lengths (600 meters, or 2100 or 2400, where vessels are equipped to transmit on those waves) for at least six hours a day while the vessel is at sea.

Third Class: Vessels of this class should carry one operator holding a commercial license of any grade, service to be such as the master of the vessel may direct.

GRADES AND REQUIREMENTS OF COMMERCIAL OPERATORS

Commercial First Grade: Code speed of 25 words a minute, as at present, the test to consist of messages, position reports and weather bulletins, transmitted without error, to be copied completely and correctly by the applicant, who should be permitted to use a typewriter for copying the test if he so desires.

In addition, the applicant should have at least three years' experience while holding third or second grade licenses, and there should be a practical examination covering those points which an operator should ordinarily learn in the course of his experience, *i.e.*, actual tuning and adjustment of different types of transmitters, spark, arc and tube; use of wave meter and decimeter; explanation of principles and calibration of radio compass; knowledge of A.C. motors and starters; correction of faults most likely to occur in arc and tube transmitters.

Commercial Second Grade: Code speed of 20 words per minute, in other respects the code test to be the same as for first grade; one year's experience while holding commercial third grade license (or equivalent experience in army or navy); practical examination in tuning transmitter to approximate wave-length without use of a wave-meter; knowledge of schedules of time signals broadcast by United States naval radio stations, and translations of weather bureau bulletins broadcast by naval stations.

Commercial Third Grade: About the same as at present, but should include a few simple problems in Ohm's law, to prove applicant understands it. Examination should also ascertain that applicant understands meaning of latitude and longitude (some of them have to learn it after they start to sea).

All licenses should be graded on a basis of 100 per cent and require a passing grade of at least 80 per cent. The present "classes" of licenses should be abolished.

Citizenship Required: All outstanding licenses now held by aliens should be revoked and no person should be examined who does not prove actual citizenship at the time of the examination.

Mates and engineers are not examined for licenses unless they are citizens of the United States, and there is no reason why this should not apply to operators. There are many aliens holding United States commercial radio operators' licenses, sailing on American vessels, who never intend to become citizens. I know one operator, a Canadian, who has sailed on American ships for seven or eight years and has not yet become a citizen of this country.

Forbidding Other Duties While On Watch: The law should forbid the company employing an operator to require him to perform any other duty during his watch. If the operator is required to do clerical work while he is on watch, he might as well turn off his receiver. He cannot maintain an alert watch while his mind is otherwise occupied. This also applies to reading, playing cards, or prolonged and unnecessary conversation with other persons while the operator is on watch. The law forbids the presence of unauthorized persons on the bridge of a ship while it is under way, and there is no reason why a similar provision should not apply to the radio room.

I believe the suggestions I have made would be of benefit both to marine radio operators and to radio service and steamship companies. Additional experience requirements and greater professional knowledge will place the operator on a higher professional plane and, in time, will result in increased respect and wages for the operator and in superior service to his employers.

WHO'S WHO AND WHERE

Arthur Gunther has taken the *SS. Coalinga*, relieving H. R. Packwood. It is rumored that Packwood came ashore to take a Y.L. to wife. Congrats, OM.

The *SS. Yale* pulled into Los Angeles last month for a slowdown. After dolling up the shack a bit, Operators Nickels and LaBalle devoted their time to seeing the sights of Southern California. (WX, please note.)

(Continued on page 62)

With the Amateur Operators

RADIO STATION 6BBV

Radio station 6BBV is owned and operated by Jack Baisby at 1010 Bates Ave., Hollywood, Calif. The transmitter is a 250 watt W.E. tube in a coupled Hartley circuit. An advance sync. gives 2200 volts on the plate, a home-made transformer 14.3 volts on the filament. With 370 mills on the plate and 50 on the grid 4.5 amps. are put in the antenna.

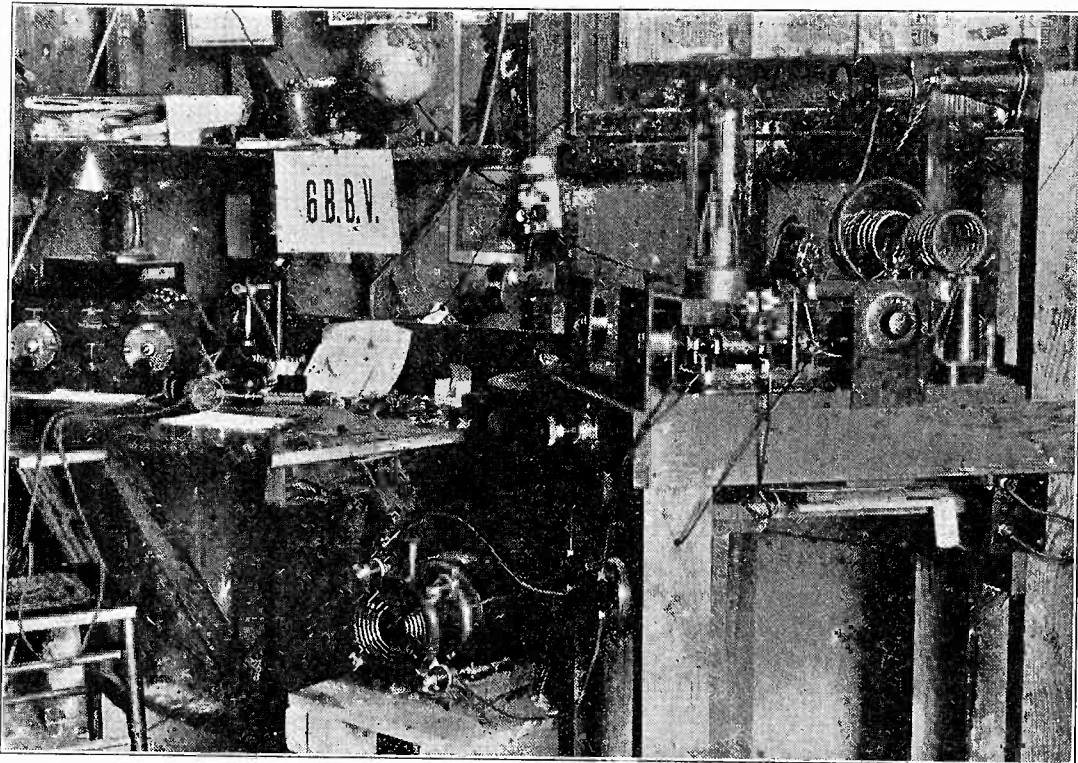

Radio Station 6BBV.

It may be noted from the picture that the socket is made of soft pine. The plate is tuned with a DXL transmitting condenser, as is likewise the grid; the open oscillating circuit is untuned.

A 1 in. copper tube 27 ft. long with 4 in. ball on top is used as an antenna and a 23 ft. tube as counterpoise. The insulators are glass towel bars.

6BBV has worked Canada, Mexico, Hawaii, New Zealand, Australia, Haiti, Samoa, Japan, China, Chile, Tasmania, Tahiti, Ecuador, England, South Africa and Philippine Islands. The receiver is a Reinartz with REL coils and one step.

News of the Amateur Operators

7QA-7IY, Wm. D. McKeeth, 412 Seventeenth Ave., South Nampa, Idaho, is on 40 meters with 50 watts, r.a.c.w.

6BP is now at 608 West 107th street, Los Angeles, Calif.

5ZAV, Le Roy Moffett, Jr., 223 East Fourth street, Oklahoma City., Okla., is back on the air with a 50-watt master oscillator on 38 meters.

6CQX has been issued as a portable to L. F. Seefred, 343 South Fremont avenue, Los Angeles, Calif.

6RO J. E. Randolph 305 30th Street, San Francisco, has been assigned the portable call 6DFF.

7ACN, James L. Young, 303 13th Ave. So., Nampa, Idaho. 7½ watts on 40 meters. All QSL's appreciated and answered.

AN IMPROVED COIL FOR SHORT-WAVE RECEPTION

By MAJOR R. RAVEN-HART

The type of coil construction herein described is suitable for use in any receiver as a fixed coil (e.g., the secondary coil in a receiver with movable tickler, the secondary and tickler coils in a "Schnell" or "Burgess" type

receiver), but its advantages are only fully realized and made use of when used with a "Burgess" type of mounting, since the proximity of the coils to the base when using the "Schnell" mounting loses much of the advantage gained by the special construction of the coil.

The wire used by the writer is No. 12 B. & S. or even heavier; not with the idea of re-

"wound on air and insulated with air" about as nearly as can be hoped for.

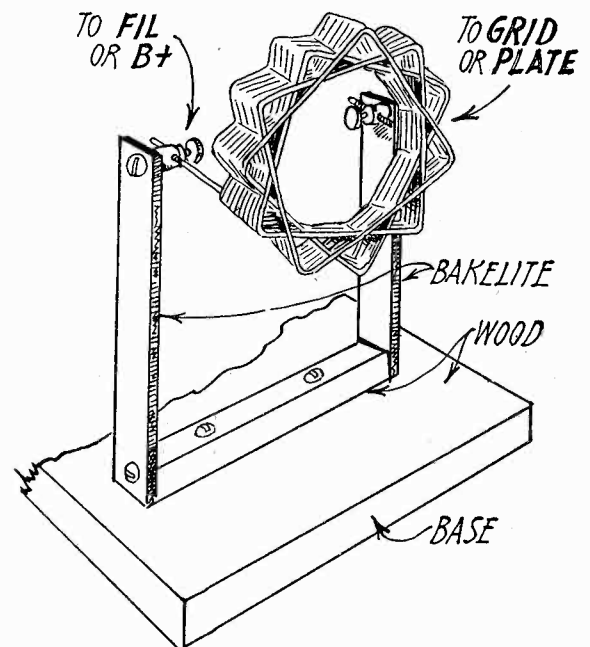

Fig. 2. Coil Assembly.

Fig. 2 shows one coil on its mounting, plan and side views. The shorter end of the coil should be held in the terminal connected to grid (plate if used as tickler). The other end of the coil is doubled back, about one in. from the turns and parallel to the axis, and goes to the terminal on the other pillar (filament or B plus).

At first sight, trouble from vibration might be expected. This is the case, if one hits the table while receiving, or uses a typewriter on the same table, but the vibration caused by writing is absolutely unnoticeable.

As already stated, the spacing between turns can suitably be the same as the diameter of the wire. Owing to the length of the coils thus produced, and their increasing mechanical weakness, this type of construction is not suitable for coils larger than 7½ turns (the half-turn being due to the end which returns alongside the coil), which with .000125 mfd. will tune from 60 to 25 meters. A 3½ turn coil will tune from about 40 to 18 meters.

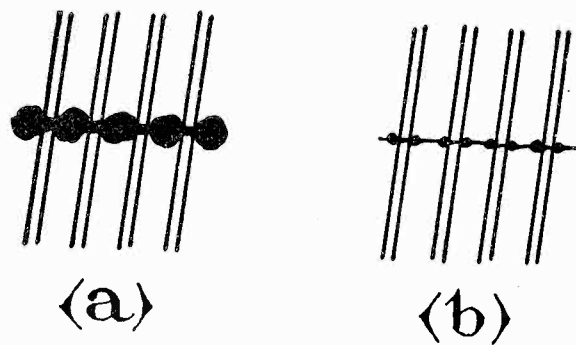

Fig. 1. Method of Binding Coil Turns.

basket weave (Fig. 1a) the turns are pressed together so that they tend to close (like the spring of a spring-balance). An attempt to avoid insulation losses has often been made by using bare wire, and tying the turns together with thick string, using large knots to separate turn from turn. In this new type of coil (Fig. 1b) the turns tend to spring apart (like the spring of a jack-in-the-box), and to keep them from doing so they are tied, at three or four points around the circumference, with very fine sewing cotton, preferably so that the spacing between turns is about the same as the diameter of the wire. There is absolutely no comparison between the quantities of "insulating" (?) material used, as will be seen from Fig. 2. It will be realized that this type of coil approaches the ideal of

BRAZILIAN QRAS

The following is an authentic list of Brazilian amateurs, and is divided into states, all calls being preceded by the letters SB.

Capital Federal

- 1 AA—Jose Jonotskoff Almeida Gomes, 23 rua Xavier da Silveira, Rio de Janeiro.
- 1 AB—Hiron Jacques, 86 rua Visconde da Gavea, Rio de Janeiro.
- 1 AC—Carlos G. Lacombe, 105 Cosme Velho, Rio de Janeiro.
- 1 AD—Pedro S. Chermont, Caixa postal n. 1663, Rio de Janeiro.
- 1 AE—Victoriano Augusto Borges, 168 rua Visconde de Silva, Rio de Janeiro.
- 1 AF—Jose Cardoso de Almeida Sobrinho, rua Buenos Aires, 41—2°, Rio de Janeiro.
- 1 AG—Edgard Roquette Pinto, 13 rua Villa Rica, Rio de Janeiro.
- 1 AH—Harold May, 65 rua dos Oitis, Gavea, Rio de Janeiro.
- 1 AI—Elvan Costa Guimaraes, Caixa postal n. 1.587, Rio de Janeiro.
- 1 AJ—Joao do Lago, 11 rua Leite Leal, Rio de Janeiro.
- 1 AK—Cid Santos, 130 rua Alzira Brandao, Rio de Janeiro.

- 1 AL—Mario Liberalli, 113 rua Voluntarios da Patria, C. VII, Rio de Janeiro.
- 1 AM—Alberto Regis Conteville, 620, rua Copacabana, Rio de Janeiro.
- 1 AN—Waldemar Aguiar, 359 rua B. de Itapagipe, Rio de Janeiro.
- 1 AO—Fernando N. Andrade Costa, Caixa postal n. 1253, Rio de Janeiro.
- 1 AP—Newton de Barros Ignarra, 48 Laranjeiras—Caixa postal n. 68, Rio de Janeiro.
- 1 AQ—Mario Barbedo, 82 rua Xavier da Silveira, Rio de Janeiro.
- 1 AR—Joaquim Paula Rosa Junior, 191 rua Grajahu, Rio de Janeiro.
- 1 AS—Francisco Penalva Santos, 17 rua Nathalia, Rio de Janeiro.
- 1 AT—Democrito Seabra, 1.170, Alto da Boa Vista—Caixa postal n. 567, Rio de Janeiro.
- 1 AU—A. F. da Costa Junior, 71 rua Itacurussa, Rio de Janeiro.
- 1 AV—Antonio da Silva Lima, 86 rua Voluntarios da Patria, Rio de Janeiro.
- 1 AW—Vasco Abreu, 89 rua Riachuelo, c/IV., Rio de Janeiro.
- 1 AX—Joao V. Pareto, 180 Praia do Russell, Rio de Janeiro.
- 1 AY—Yvonne Moorby, Caixa postal n. 1.595, Rio de Janeiro.
- 1 AZ—Juvenil Pereira, 52 rua do Livramento, sob., Rio de Janeiro.
- 1 BA—Narciso dos Anjos Lima, 149 rua Jose Clemente, Rio de Janeiro.
- 1 BB—Raul Kennedy de Lemos, 106 rua Barroso—Caixa postal n. 1.587, Rio de Janeiro.
- 1 BC—Raul Berrogain, 144 rua Gomes Carneiro, Rio de Janeiro.
- 1 BD—Alberto L. Villela, 76 Cosme Velho, Rio de Janeiro.
- 1 BE—Manoel Macedo, 239 AV. 28 de Setembro, c/IV., Rio de Janeiro.
- 1 BF—Alberico Tavares, 19 rua Senador Dantas, Rio de Janeiro.
- 1 BG—Gentil Pinheiro Machado, 46 Av. Rio Branco, 1° andar, Rio de Janeiro.
- 1 BH—Godofredo Damm, 114 Estrada Itarare, Ramos, Rio de Janeiro.
- 1 BI—Luiz G. Cardoso Ayres, Caixa postal n. 152, Rio de Janeiro.
- 1 BJ—Jose Pinto Meira de Vasconcellos, 80 rua Barao de Itamby, Rio de Janeiro.
- 1 BK—J. Cerqueira Roos, 139 rua Paysandu, Rio de Janeiro.
- Estado Do Rio**
- 1 IA—Humberto Silva, 20 rua Coronel Julio Abreu, Nilopolis.
- 1 IB—Alvaro S. Freire, 46 rua Oswaldo Cruz, Nicteroy.
- Estado Do Espirito Santo**
- 1 QA—Aluizio Lima Campos, Banco do Brasil, Victoria.
- 1 QB—Quintino Bocayuva Netto, Companhia Costeira, Victoria.
- Estado de S. Paulo**
- 2 AA—Leonardo Y. Jones Junior, 22 rua Frei Caneca, St. Paulo.
- 2 AB—Severiano Justi, 19 A, rua Visconde do Rio Branco, S. Paulo.
- 2 AC—Luiz do Amaral Cesar, 20 A, rua Frei Caneca, S. Paulo.
- 2 AD—George Corbisier, 24 rua Rodrigo de Barros, S. Paulo.
- 2 AE—Julio Boccolini, 51 Av. Angelica, S. Paulo.
- 2 AF—Joao Sampaio Goes, 96 rua Cardoso de Almeida, S. Paulo.
- 2 AG—Cesar Yazbek, 12 rua Ypiranga, S. Paulo.
- 2 AH—Joao Tonglet, 73 A rua Barao de Itapetininga, S. Paulo.

ADVANCE

"SYNC" Rectifier the favorite

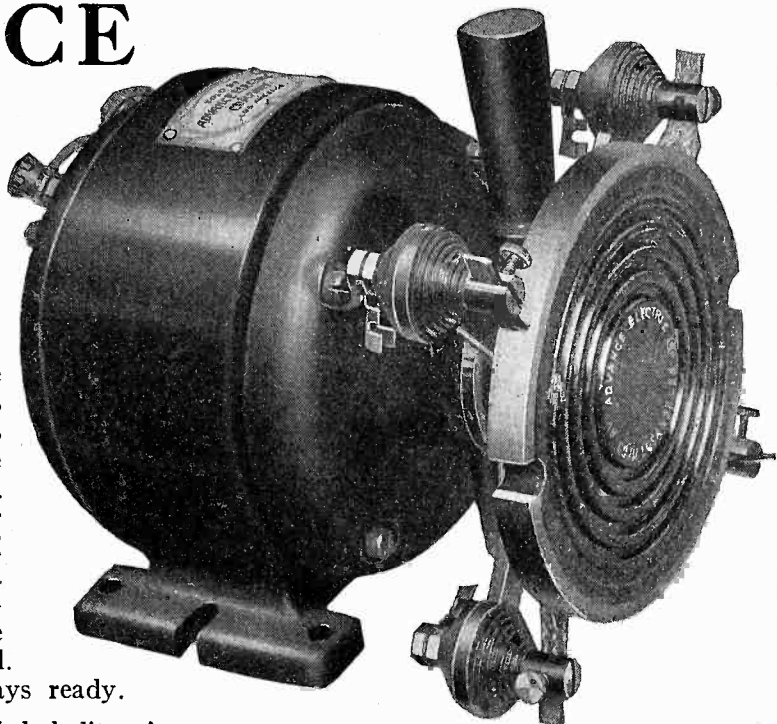

Although lower in price, the ADVANCE Sync Rectifier is far superior in quality—as proven by its prevailing use in international transmitting. It actually does what other rectifiers claim to do. Meets all requirements for heaviest duty. Can be easily and quickly filtered. Speedy starting because of Advance Bakelite wheel. Requires no attention—always ready.

Revolving disk is moulded bakelite six inches in diameter. Nickel plated brush holders with adjustable gauze copper brushes. Convenient control handle. Disk, aluminum brush arm support and brush holders perfectly insulated.

Price complete with Westinghouse 1/8 H.P. Synchronous Motor\$40
Rectifying wheel with complete brush assembly and mounting ring to fit your own motor\$15

ADVANCE ELECTRIC COMPANY
1262 W. Second Street, Los Angeles, Calif.

WE PAY ALL TRANSPORTATION CHARGES IN U. S. A.

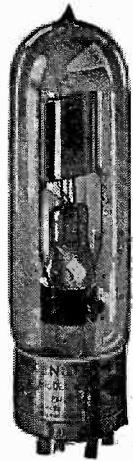

Never Before At This Sacrifice Price HIGH VOLTAGE

RCA KENOTRON RECTIFYING TUBES RCA MODEL U. V. 217

A. C. Plate Voltage 1500 volts. Filament Voltage 10 volts.

Used with U. P. 1016 Power Transformer or similar Transformer.

These GENUINE R.C.A. U. V. 217 Tubes are very efficient Rectifiers and they will pass plenty of current and voltage for 50 watters and H. Tubes and also can be used for 250 watters.

EVERY TUBE IS BRAND NEW AND PACKED IN ORIGINAL CARTON

List Price \$26.50 ea.

EXTRA SPECIAL \$12.50 EA.

AMERICAN SALES COMPANY

21 WARREN STREET

NEW YORK CITY

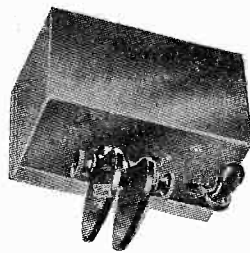

**\$12.50
DIRECT
TO YOU**

Semi-automatic transmitter; platinum points, adjustable speed, nickel plated case with lock and key. Order today. K. N. FORD, 1411 1/2 Alta Vista Blvd., Los Angeles, Calif.

Third Edition—Revised

Best Radio Book Ever Published

"RADIO THEORY AND OPERATING"

By MARY TEXANNA LOOMIS

885 Pages—700 Illustrations—Price \$3.50. Used by the Department of Commerce, all U. S. Naval Training (Radio) Schools, U. S. Coast Guard Academy, U. S. Signal Corps. also all Radio Institutions in U. S. and Canada and many Universities, Technical Colleges, and High Schools. Buy of your dealer, or send us check, express, or money order.

LOOMIS PUBLISHING CO.

Dept. X, 405 Ninth Street, Washington, D. C.

JACOBS ANTENNA SPREADER

DIAMETER 7 INCHES

Patented Sept. 8, 1925; Sept. 7, 1926

Made of metal for erecting 4, 6 or 8 wire Cage Antenna or Counterpoise.

Being used at present by transmitting amateurs, experimenters, and those desiring long distance broadcast reception.

Price \$5.00 per dozen; \$2.75 for a half dozen. Circular upon request.

CHARLES F. JACOBS, (2EM), 279 Park Place, Brooklyn, N. Y.

Reception as it should be

If you think that you are getting 100% reproduction—just listen to a set equipped with Ferranti Transformers. You'll note the difference. *Every* tone—*every* note—reproduced with living reality! That is something worth having. And that is exactly what you can get by the simple process of modernizing *your* set with Ferranti Transformers.

Some Good Reasons—

High amplification ratio with flat curve.

Ferranti brings out the fundamental frequency of low tones—none are heard merely by inference from higher harmonics.

Every transformer tested ten times—all short circuited turns eliminated.

Tested to 1000 volts between primary and secondary and between primary and secondary and ground. Therefore specially suited for use with power tubes requiring high plate voltages.

Primary shunted with built-in condensers of correct capacity.

Built by an established manufacturing company with forty years' experience in the winding of coils of fine wire for electrical instruments and meters.

For the best results—two Ferranti Audio Frequency Transformers type A.F. 3—ratio $3\frac{1}{2}$ to 1—\$12.00 each. For results far superior to the average, use two Ferranti Transformers type A.F. 4—ratio $3\frac{1}{2}$ to 1—\$8.50 each.

FERRANTI, Inc.

130 WEST 42ND STREET, NEW YORK CITY

Pacific Wholesale Radio Co., 1310 South San Pedro St. Los Angeles, Calif.	The Electric Corporation, 1050 Santee Street, Los Angeles, Calif.
---	---

Pacific Wholesale Radio Co.,
127 12th St., Oakland, Calif.

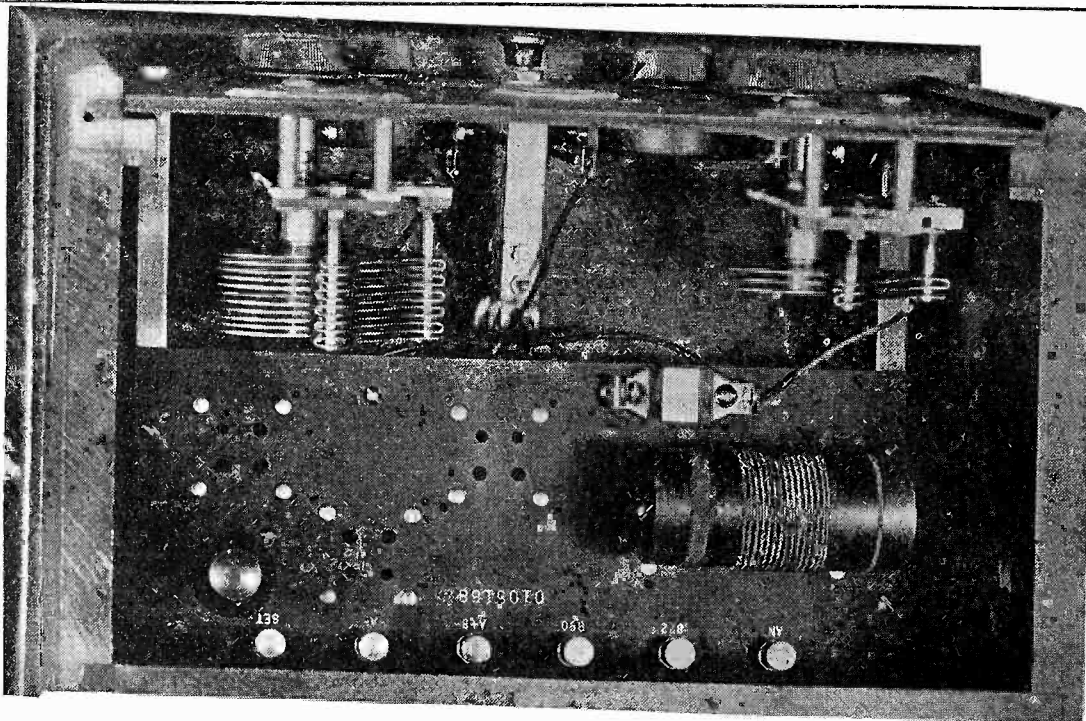
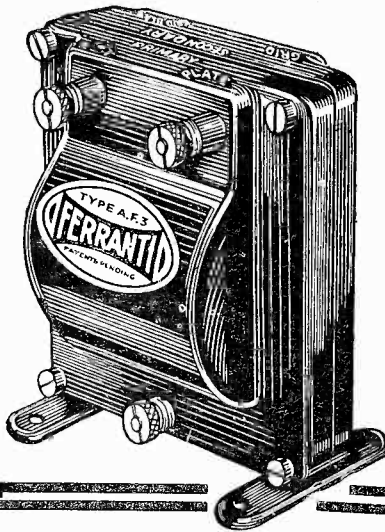

- 2 AI—Luiz F. de Mesquita, 73 Av. Paulista, S. Paulo.
- 2 AJ—Joao Ramos Baccarat, 504 rua Conselheiro Nebias, Santos.
- 2 AK—Carlos Baccarat, 488 rua Conselheiro Nebias—Caixa postal n. 57, Santos.
- 2 AL—Joao Levy Silva, 49 rua Arthur Prado, S. Paulo.
- 2 AM—Joao Cancellia, 64 rua Frei Caneca, S. Paulo.
- 2 AN—Theodoro de Toledo Piza, 300 Bella Cintra, S. Paulo.
- 2 AO—Henrique Lindenberg, 7 rua Guadeloupe, S. Paulo.
- 2 AP—Paulo Yasbek, 12 rua Ypiranga, S. Paulo.
- 2 AQ—Jose Saez, 59 rua S. Pedro, Villa Marianna, S. Paulo.
- Estado Do Rio Grande Do Sul
- 3 QA—Tyrteu Rocha Vianna, Praca, 15 de Novembro s/n, S. Francisco de Assis.
- 3 AA—Pedro Carlos Schuck, 3 rua D. Laura, Porto Alegre.
- Estado De Pernambuco
- 5 AA—Tito de Araujo Firmo Xavier, 110 rua Padre Lemos, Recife.
- 5 AB—Joao Cardoso Ayres, 251 rua Bemfia—Caixa postal n. 257, Recife.
- 5 AC—Severino de Mendonca, 127 rua Azeredo Coutinho, Recife.

THE BROWNING-DRAKE RECEIVER

(Continued from page 12)

panel and metal cabinet will stop any pick-up from the local stations on the coils and wires of the set so that outside stations should be easily tuned in while locals are operating.

Do not expect to get 2,000 or 3,000 miles with the receiver every night—static and other interference will not permit it on any set, no matter if it cost a thousand dollars. However, the receiver described, if carefully built and operated, will give the constructor a pleasant surprise.

The best antenna is a vertical aerial of from 50 to 70 ft. in length. The receiver performs well on a much shorter one, such as 10 to 20 ft. of wire in same room with the receiver. It should be placed as high above the set as possible. Good insulation on the antenna system is important. The ground connection should be made to a water pipe by means of a ground clamp.

FROM THE RADIO MANUFACTURERS

The Crosley Lowave is an adaptor for enabling the short-wave programs from KDKA, WGY, WLW and other stations to be heard on any 200-600 meter receiver. The unit is essentially a short-wave tuner with regenerative detector and one stage a.f., whose output modulates a 1000 k.c. frequency from an oscillator tube. This is conducted to the receiver through its antenna connection, the receiver being tuned to 300 meters (1000 k.c.). The energy is here amplified and detected in the usual manner. The oscillator frequency is adjustable so as to obviate local interference. Two short-wave plug-in coils are furnished, one for the 28-45 meter range and the other for the 40-80 meter range.

(Continued on page 58)

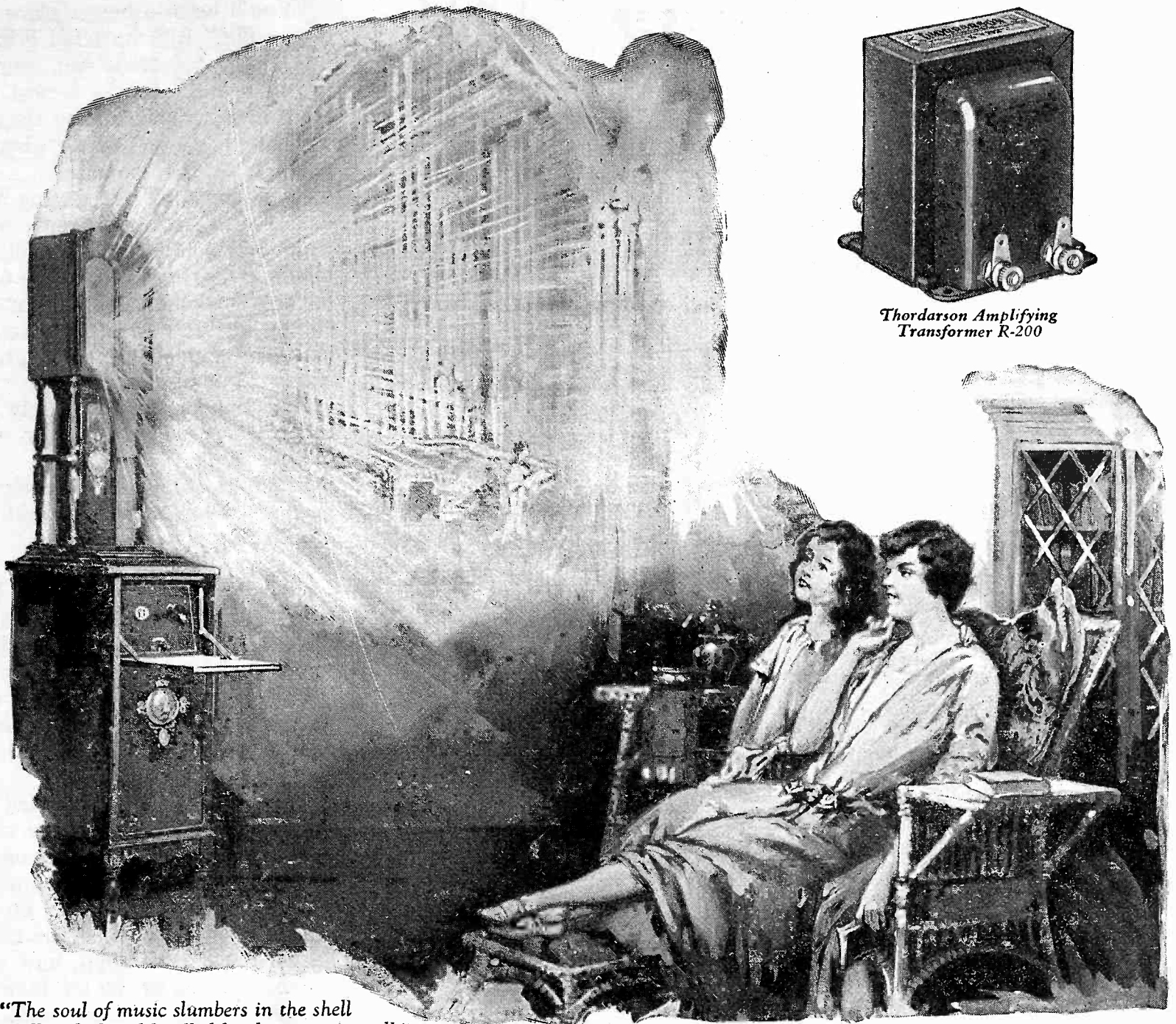

Thordarson Amplifying
Transformer R-200

"The soul of music slumbers in the shell
Till waked and kindled by the master's spell."
(Samuel Rogers — "Human Life").

WITHIN your set slumbers a world of music which you can charm to a living fullness and richness of tone by installing Thordarson Amplification.

The manufacturers of leading quality receivers have recognized in Thordarson Amplifying Transformers a fidelity of musical reproduction which removes the ordinary artificial tones of radio and replaces them with living harmonies.

Whether you are buying a complete receiver, or whether you are building your own—if you enjoy music—be sure that your transformers are Thordarsons.

THORDARSON

RADIO TRANSFORMERS

Supreme in Musical Performance!

THORDARSON ELECTRIC MANUFACTURING CO.
Transformer Specialists Since 1895
WORLD'S OLDEST AND LARGEST EXCLUSIVE TRANSFORMER MAKERS
Huron and Kingsbury Streets — Chicago, Ill. U.S.A.



(3550)

(Continued from page 12)

"You'll be in a hotter place than this if you die," Bill muttered grimly. But he finally relented and counted out fifteen beans. It was almost pitiful to see the way Juan gobbled them up.

That night we camped about twenty miles from the mountains. Juan sat morosely by the fire digesting his twenty beans—Bill gave him twenty at night—while Bill and I climbed a little hill to take our bearings and decide our course for the next day. The mountains were clearly visible now, and directly before us there seemed to be a great hunk scooped out of the foothills.

"See that?" said Bill wisely. "That's the entrance to some valley or canyon or something."

"U-huh," I admitted dubiously. "I suppose you know as much about it as any of the rest of us."

"If we don't find a village up there I shall miss my guess," said Bill modestly. "And even if there isn't a village there'll probably be water and fish and some kind of bird or—or something."

I seemed to notice that Bill used that word *something* pretty frequently, but I didn't mention it to him. Bill is touchy like that.

The next day we headed for the mountains, and at night we camped in the mouth of the little canyon beside a flashing stream. The water made us feel so good that Bill plunged on our evening meal. He opened the last can of beans, the can of soup, and sliced the bacon. Moreover, he let Juan have his full share.

I waked the next morning before sunrise with the firm conviction that I was strolling down a steep hill which had huge bumps distributed at regular intervals. It was Bill. He was standing over me and kicking me systematically.

"Crawl out of it," he advised, when I began to show signs of reviving life. "It's morning and we haven't any food left. If we hike about fifty miles up this canyon we may see a fish or something for breakfast."

I remonstrated with him to the effect that I was perfectly willing to lie there the rest of day and let him go on, but he started in double time with his kicks. I rose hastily. Bill has large feet.

While I was making my toilette, which consisted in dipping my face into the stream several times, Bill caught Juanita and packed up. I noticed that he had been fooling with the radio set, and when we were started up the canyon I asked him about it.

"Couldn't pick up a darn thing," he admitted. "I did get a little spurt of code from some Pacific steamer, but it faded on me. Must be these blasted mountains."

(Continued on page 44)

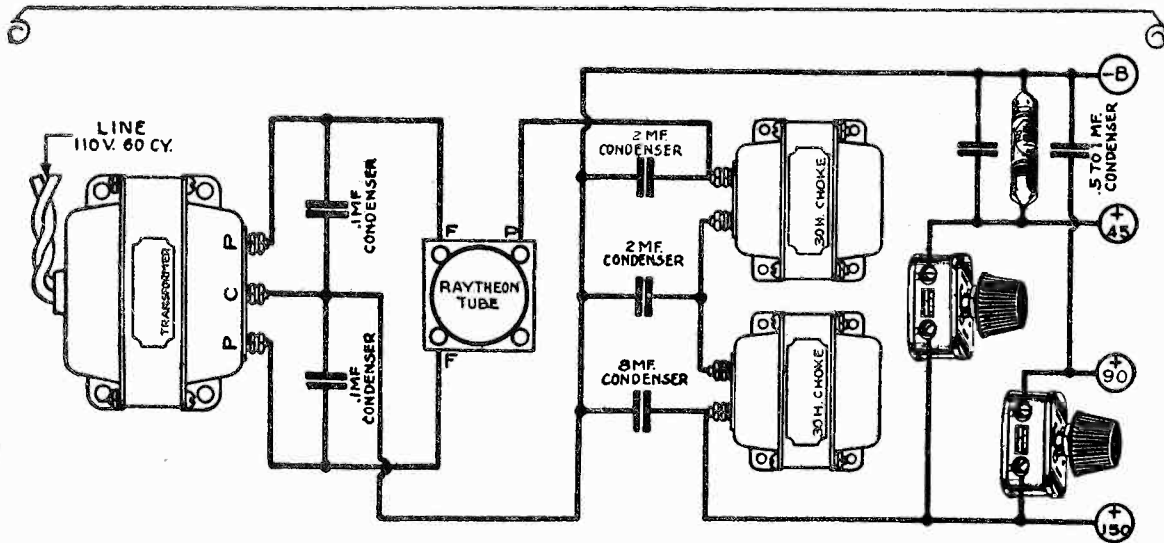

Improve Your B-Eliminator with Allen-Bradley Resistors

WHEN you build a B-Eliminator, be sure that your kit contains Bradleyohm-E for plate voltage control and Bradleyunit-A for the fixed resistors. Then you will be assured of perfect plate voltage control.

Bradleyunit-A

PERFECT FIXED RESISTOR

This solid, molded fixed resistor has no glass or hermetic sealing in its construction. It is a solid unit, molded and heat-treated under high pressure, that is not affected by temperature, moisture and age. The end caps are silver-plated, and can be soldered without affecting the accuracy of the Bradleyunit. By all means, use Bradleyunit-A when you need a fixed resistor in your radio hookup.



Bradleyohm-E

PERFECT VARIABLE RESISTOR

This oversize variable resistor is used as standard equipment for accurate plate voltage control by leading B-Eliminator manufacturers. The scientifically treated discs in Bradleyohm-E provide stepless, noiseless, plate voltage control, and the setting will be maintained indefinitely. Ask for Bradleyohm-E.

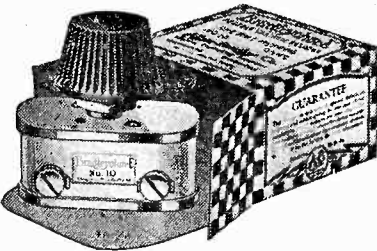

Always insist that Bradleyohm-E and Bradleyunit-A are included with your B-Eliminator kit. You then will be assured of perfect voltage control.

ALLEN-BRADLEY COMPANY
279 Greenfield Ave. :: Milwaukee, Wis.

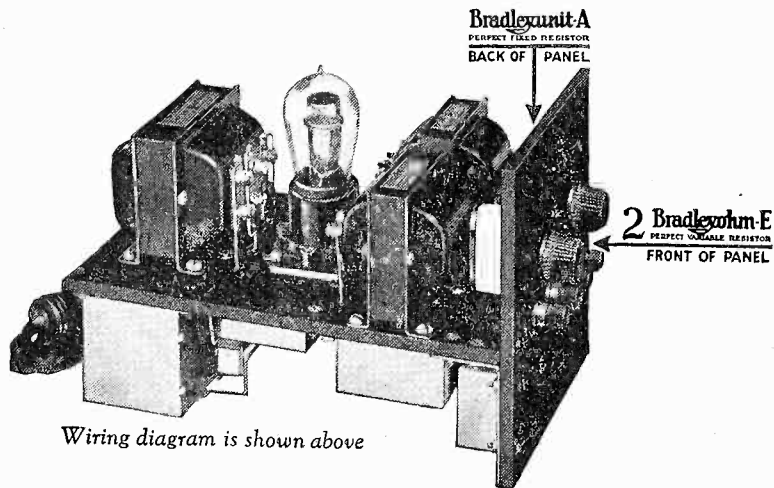

Wiring diagram is shown above

Write for
Folder
Giving Seven
B-Eliminator
Hookups.

Use Allen-Bradley Perfect Radio Devices

“When a Feller Needs a Friend”

Briggs' familiar title for his inimitable cartoons is recalled to mind by the following letter from a radio dealer:

“When a customer comes in and asks for Bremer-Tully products I know he either knows a good deal about Radio or has a good friend who does . . .”

If you have followed radio for some time you probably know that every B-T product has been an outstanding success. No doubt you have at some time or other said a good word for B-T to some of your friends.

We want you to become better acquainted with some of our latest developments in Complete Receivers, Kit Sets and B-Power Units. The 11th Edition of *Better Tuning* gives complete information on these subjects as well as our views on other radio topics.

If you will send us the name and address of a few friends who are interested in radio, we will gladly send each one a copy. Use the coupon.

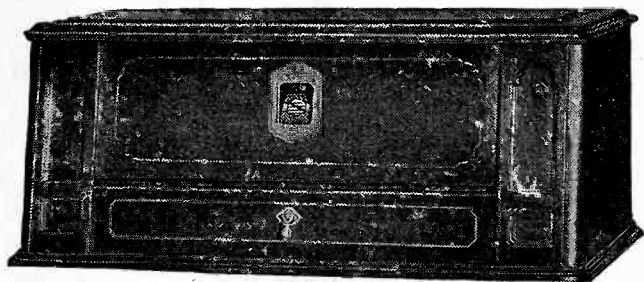

COUNTERPHASE - EIGHT

In spite of its great *sensitivity* and *selectivity*, the *Counterphase-Eight* is extremely simple to operate. There are only two main controls—one for selecting stations and one for volume. Stations are read directly in wave-lengths—*accurately*, because each set is individually calibrated. Inexperienced persons can almost immediately secure full efficiency.

Numerous features, many exclusively B-T, are discussed in *Better Tuning*.

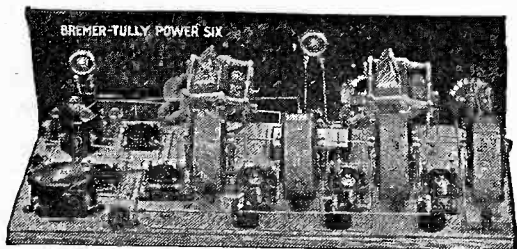

POWER-SIX FOR THE HOME SET-BUILDER

Gerald M. Best says—“*The new B-T Power-Six is by far the best B-T receiver yet developed. . . . It is one of the easiest circuits to wire of any I have seen. Its engineering principle is sound. . . .*”

It's the real set for the home set-builder. Essential parts available in kit form at all high-grade dealers.

BREMER-TULLY MFG. CO.

520 SO. CANAL STREET, CHICAGO, ILL.

B-POWER UNIT

There is no guessing the voltage delivered when you use the Bremer-Tully B-Power Unit. No variable resistances — no knobs to turn.



You simply plug in on the front panel and insert the fixed wire wound resistances as directed. There is nothing further to be done, simply turn the switch and the current voltage is delivered.

It is on sets using power tubes that a B-Power Unit is needed and economical. To properly operate the power tube the voltage must be reasonably close to the tube manufacturers recommendations. The B-T Unit delivers 150 volts at 60 milliamperes enough for multi tube sets using the power tube.

Please send me a copy of the 11th Edition, “Better Tuning.”
I am also attaching the names and addresses of a few friends who would be interested in a sample copy of your booklet.
I am interested in [] Counterphase Receivers, [] Kits for the set-builders, [] B-Power Units.

(Please print name)

(Address)

R-3

(Continued from page 42)

"Don't you think we may get something after we get up higher?" I asked him.

"I don't know, Al," said Bill to me, seeming a bit worried. "I had been sort of banking on it to get us some supplies when we find a town."

"Supplies? With a radio receiver?"

"Sure. The moral influence of it, you know." He looked at me mysteriously. "These mountain villages up here have never heard of such a thing as radio. If we could just pick up a program and switch on the loudspeaker I'll bet we could command all the supplies in sight. Probably they'd want to kiss our feet and offer us whole roasted steers with gravy dripping from them. They'd think we were gods to pick sounds out of a horn like that!"

"Holy Cats!" I murmured, my mouth beginning to drool. "Did you say 'dripping gravy'?"

"Fat chance," Bill snorted. "Didn't I just tell you that I couldn't pick up anything loud enough to work a loudspeaker? And if you think you could get one of these Aztec babies to stick his head in a headset, you've got another thought on the way!"

I had forgotten about that, and Bill's hopeless voice knocked all thoughts of gravy from my mind. I walked along dismally, and pretty soon I heard a funny mumbling from Juan's vicinity.

"That's Juan," said Bill mournfully, "He's walking along saying his prayers and counting the beads of his rosary. He thinks we're all going to starve to death."

* * * *

THE canyon seemed to be narrowing down now. At first it had been a kind of valley with the stream splashing down a little gulch in the center; but now it had become a high-walled gash in the mountain not more than a quarter of a mile wide. On the slopes above us were growing clusters of brilliant red and yellow flowers. All along the border of the stream grew a thick fringe of bay and sycamore trees, all incredibly green.

Somewhere near noon Bill discovered some ripe thimble berries which he charitably shared with us. Juan still mumbled an occasional prayer, but the luxuriant growth of the canyon was beginning to impress him, too, and his petitions were becoming less fervent.

Suddenly, it seemed almost in an instant, the canyon had narrowed down to a twelve foot gorge. We began to have difficulty in keeping out of the stream.

"Al," said Bill to me presently in a low voice, "I have a hunch that we're getting near to something!"

"Something?" I began to feel the gooseflesh rise. "You don't mean to say there is—er—something up here?"

"Just wait," he assured me confidently. "This gorge can't go on like

(Continued on page 46)

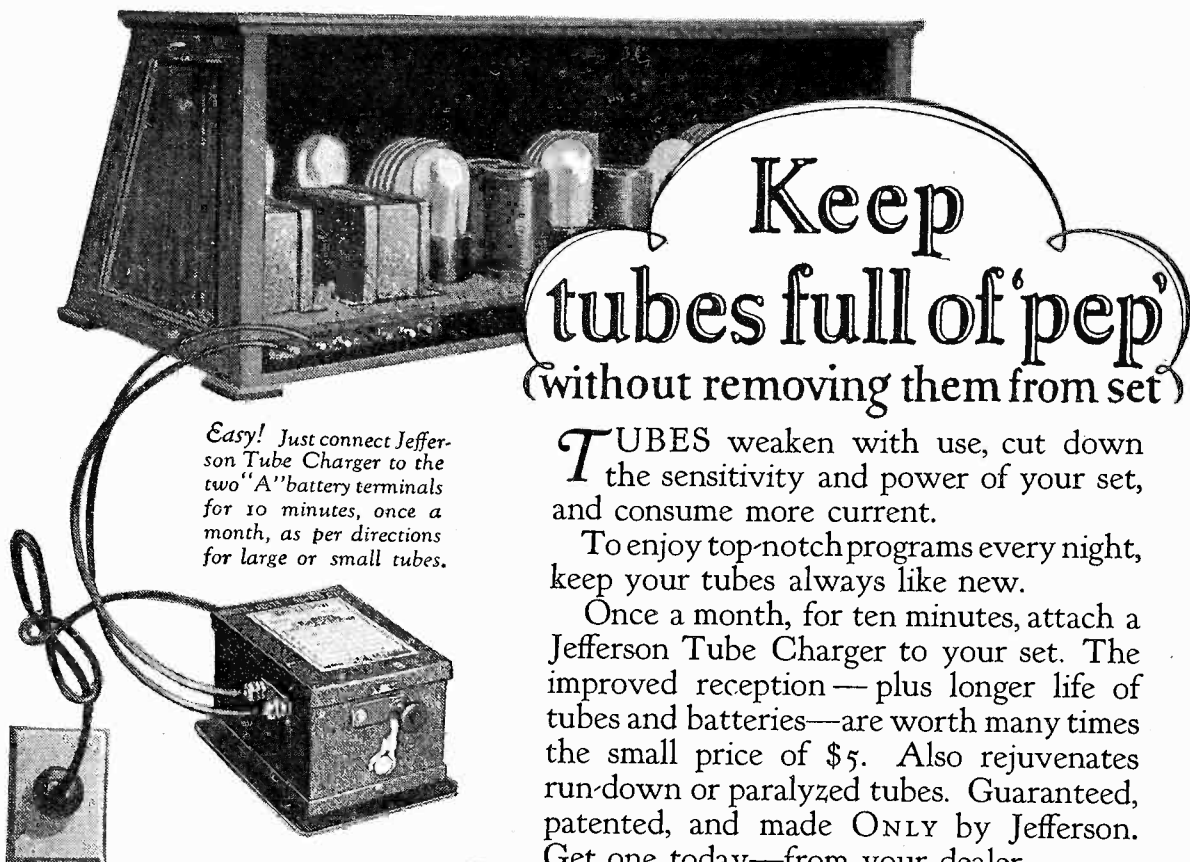

Easy! Just connect Jefferson Tube Charger to the two "A" battery terminals for 10 minutes, once a month, as per directions for large or small tubes.

Keep tubes full of 'pep' (without removing them from set)

TUBES weaken with use, cut down the sensitivity and power of your set, and consume more current.

To enjoy top-notch programs every night, keep your tubes always like new.

Once a month, for ten minutes, attach a Jefferson Tube Charger to your set. The improved reception—plus longer life of tubes and batteries—are worth many times the small price of \$5. Also rejuvenates run-down or paralyzed tubes. Guaranteed, patented, and made ONLY by Jefferson. Get one today—from your dealer.

JEFFERSON ELECTRIC MFG. CO.
Largest manufacturers of small transformers
502 So. Green Street, Chicago
[PATENTED]

Jefferson

No. 275 Tube Charger

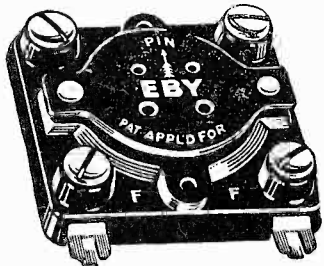

Eliminate the Jar and SAVE the Tube!

"I find the contact in the EBY Socket exceptionally good in protecting the filament from damage when the tubes are interchanged"—says a prominent circuit designer.

EBY Sockets provide a three point wiping contact at all times and reduce microphonic noises to a minimum. You can buy them at your dealers for 50c.

EBY BINDING POSTS

are recommended and specified for building these and many other successful circuits.

Browning-Drake
Cockaday LC 27
Hammarlund-Roberts
Infradyne
LaCault LRA

St. James
Varion
Kenneth Harkness KH 27
Victoreen
General Radio 400



THE H. H. EBY MANUFACTURING CO
4710 Stenton Ave. Philadelphia

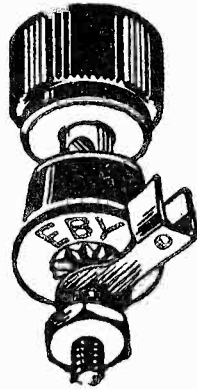

HEAR the wonderful New Acme Speaker at your dealer's

ACME
for amplification



FIRST CLASS

TRICKLE CHARGER \$2.50

in U.S.A. when cash accompanies order. Complete parts 6 ft. extension cord—nothing else to buy. Simple instructions, screwdriver, pliers and 30 min. work. Guaranteed to work on any A. C. socket. Post prepaid. X-L RADIO SALES, Dept. R. 2424 Lincoln Ave., Chicago, Ill.

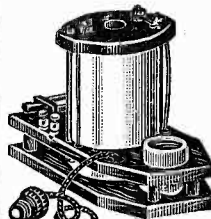

Tell them that you saw it in RADIO

NEW!

Eveready Layerbilt
"B" Battery No.
486, the Heavy-
Duty battery that
should be specified
for all loud-speaker
sets.

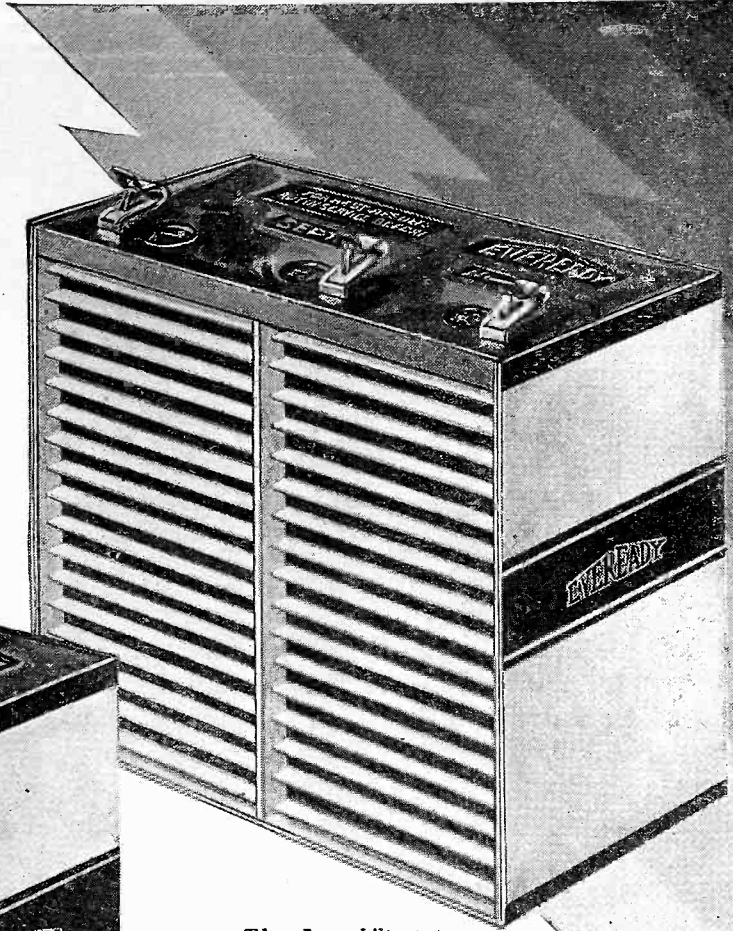

The Layerbilt patented construction revealed. Each layer is an electrical cell, making automatic contact with its neighbors, and filling all available space inside the battery case.

DIFFERENT!

For greatest economy all loud speaker sets require the new Eveready Layerbilt "B" Batteries

IT WILL pay you, in convenience and reliability as well as in dollars and cents saved, to use this remarkable battery.

The reason for the Eveready Layerbilt's surprising performance lies in its exclusive, patented construction. No other battery is like it. It is built in flat layers of current-producing elements, making practically a solid block. The layers make connection with each other automatically, and occupy all available space inside the battery case. Layer-building

packs more active materials in a given area, and makes those materials produce more electricity.

Every loud-speaker set should use Heavy-Duty batteries, for they alone offer economy on modern receivers. When you buy new "B" batteries, be sure to get the Heavy-Duty size, and remember that the Eveready Layerbilt has proved to be the longest lasting, most economical of all Heavy-Duty batteries.

Our laboratories are continually testing batteries, and in all

our tests we have yet to find a battery that is equal to the new improved and radically different Eveready Layerbilt "B" Battery No. 486. The development and perfecting of this remarkable battery is an outstanding battery-building achievement. It is the result of many years' experience plus the facilities and resources of the pioneer manufacturers of all dry cell batteries.

NATIONAL CARBON CO., INC.
New York San Francisco
Unit of Union Carbide and Carbon Corporation

Tell them that you saw it in RADIO

(Continued from page 44)

this forever."

"Obviously not," I admitted.

"Don't get previous!" snapped Bill. "What I mean is that this place can't get much narrower. It stands to reason that this stream is coming from somewhere, and it's the dry part of the year. What would this place be like in winter?"

"The inside of a water main," I suggested amiably. Conversation always makes me feel better.

"You're right," said Bill. "Also, there must be some big supply of water somewhere to keep it going at all in summer. I wouldn't be surprised if we should come to a lake or something pretty soon—Great guns and revolvers!"

We had just made a sharp turn in the canyon, and Bill jerked his finger up excitedly. "Just look at that!"

At Bill's suggestion I lifted my eyes and looked. I don't usually go into raptures about the beauties of nature, but the little valley which was spread out before us was the neatest thing in choice homesites that I had ever glimpsed. The gorge through which we had been traveling ended abruptly. And stretching before us, perfectly level for a couple of miles, was a green grassed valley flanked on two sides by glittering, snow-capped peaks. In the center, as Bill had guessed, was the lake which fed our stream; and tinkling down to it from the mountains were dozens of tiny waterfalls, glistening like silver ribbons in the sunshine.

What interested me most was the town. I could see, even at that distance that the houses were of adobe. In the meadows I could see people working, and in one place was a great herd of scrubby, long-horned cattle.

"Good Gosh!" breathed Bill in a kind of fascinated whisper. "Talk about idols—how's that!"

With a little shock of surprise I noticed that he wasn't looking at the beefsteak herd, and so I followed his gaze. For a moment I was almost horror stricken myself.

Facing us, on a little plateau not a hundred yards away, was the most hideous image I have ever seen. It seemed to be built of stone. And from its huge, misshapen feet to its tusked, half-man and half-goat head it was about fifty feet high.

Suddenly Juan saw it, and I thought he would keel over. His yellow skin turned the color of dirty chalk and he backed toward the gorge.

"Diablo!" he gurgled. "Thees place ees no good. We shall go back with me!"

Bill whirled around at that, and grabbing Juan by the neck gave him a tremendous kick toward the idol.

"Try it!" he grated feelingly. "After

(Continued on page 50)

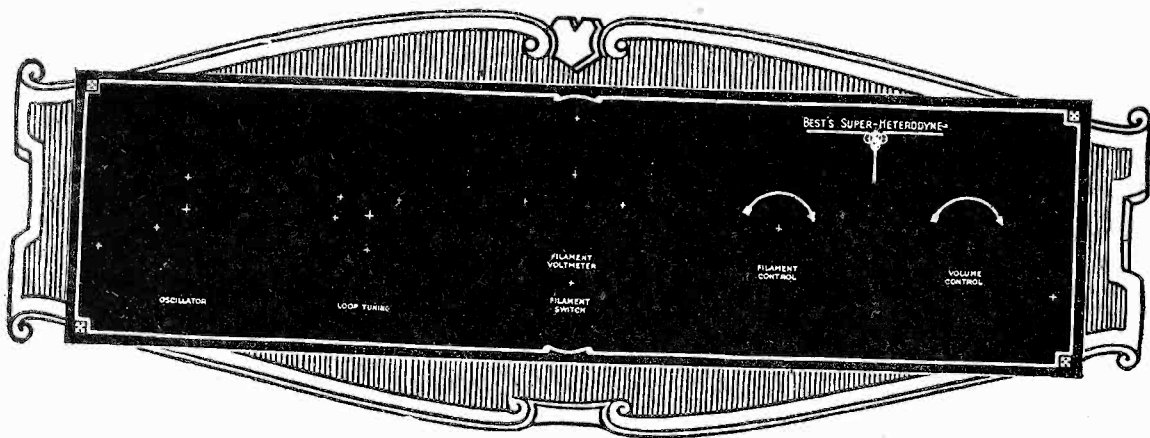

BEST'S SUPER, KARAS, H. F. L.

Formica is supplying handsomely decorated kit panels for leading kit sets through leading jobbers and dealers all over the country. These panels make it possible to build at home a very good looking set. There are two sizes of Best's Super-heterodyne, Karas Equamatic front and sub-panels, H. F. L. Nine-in-Line Superheterodyne with sub-panel, Victoreen single dial control and two dial control. There is also an Infradyne 7"x28" and one 7"x30", Aerodyne, St. James 8 Tube, Browning-Drake National, Madison Moore Superheterodyne and Camfield Duoformer. They are sold by leading jobbers and dealers.

Special panels cut to size and Formica Tubing are also available for amateurs.

THE FORMICA INSULATION COMPANY
4616 Spring Grove Avenue, Cincinnati, Ohio

Hear the FORMICA
Orchestra Tuesday
9 to 10
over WLW



Formica has a
Complete Service on
Insulating Material for
Radio Manufacturers

CeCo Type "H"

The Special Hard Detector that eliminates that frying, hissing noise

Will give improved reproduction and avoid the usual rushing and hissing sounds of the "soft" detectors.

Using a higher plate voltage than previous types, it will handle powerful signals with less overloading. Average mutual conductance 940. Voltage Amplification factor 14.4.

Price \$2.50

Write for Complete Data Sheet
C. E. Mfg. Co., Inc., Providence, R. I.

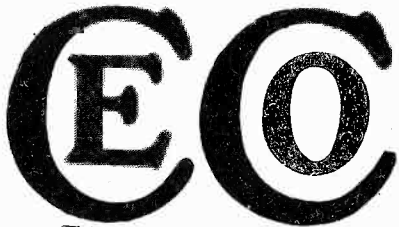

A Type for Every Radio Need

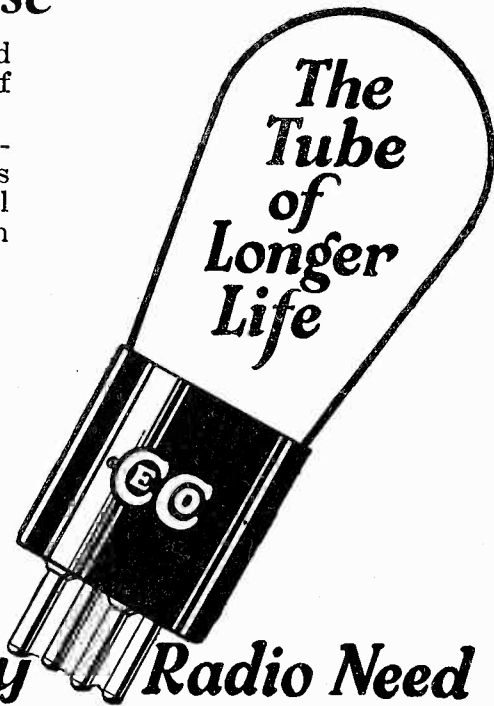

USE "RADIO'S" NEW LABORATORY SERVICE

Write today for rate schedule for matching and testing your radio parts. We are equipped to give you prompt service.

"RADIO"—Pacific Building, San Francisco, Cal.



Now- ALCOA ALUMINUM Box Shields



To meet the growing demands of new radio design, which insist upon shielding, the Aluminum Company of America now provides a Box Type Shield.

Aluminum, used with success in the Alcoa Wing Type Shield (for interstage shielding) gives the set builder and the manufacturer an adaptable, easily-worked material of great durability and shielding performance combined with extreme lightness. Its uniformly high quality, judged from both metallurgical and radio standards, is established.

The New Alcoa Box Shield is especially designed to be of the greatest use to the greatest number of set builders. If it does not suit your size requirements exactly you will find that a few moments' easy work will adapt it most satisfactorily to your needs—being easily cut, easily worked and permanent when assembled.

Alcoa Aluminum Box Shields

are shipped knocked-down. Of heavy sheet, about the thickness of a half-dollar, (.080"—No. 12 B & S) to be completely effective for shielding.

Consists of: Top, Bottom, Sides;
4 Extruded Corner-Posts;
8 Aluminum Screws.

Assembles 5" x 9" x 6".

Easily modified.

Ask your dealer, or write us.

Some Other Applications of Aluminums:

Alcoa Shields,
Box Shields,
Cabinets,
Panels,

Variable Condensers,
High-purity Rods,
Foil for Fixed Condensers
Die-Castings,

Screw Machine Products

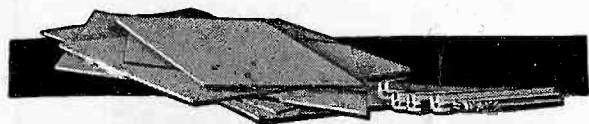

ALUMINUM COMPANY
of AMERICA

2323 Oliver Building, Pittsburgh, Pa.



AMERTRAN RADIO PRODUCTS

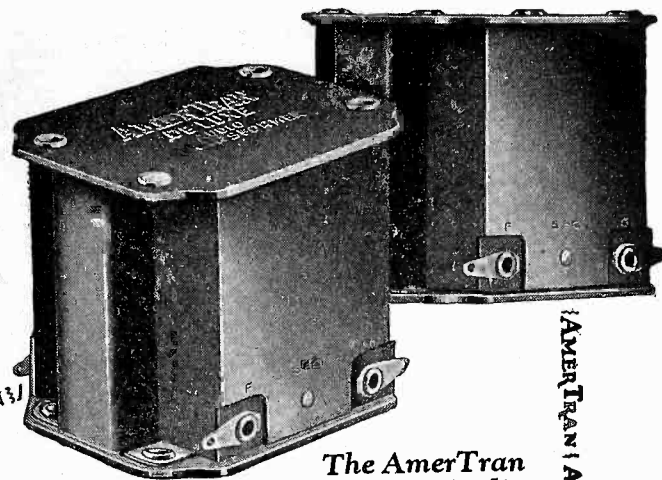

The AmerTran
De Luxe Audio
Transformer
Made for 2 stages

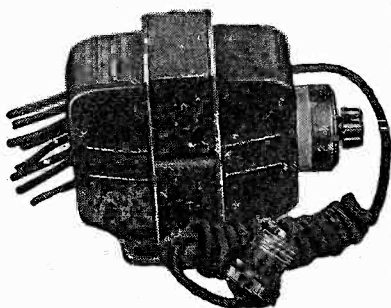

The AmerTran
Power Transformer
Type PF-52

Type PF-52 is intended for use in the better type of power supply developments. It will convert the standard 110 volt, 60 cycle alternating house lighting current to a higher voltage for the plate and lower voltage for filament supply.

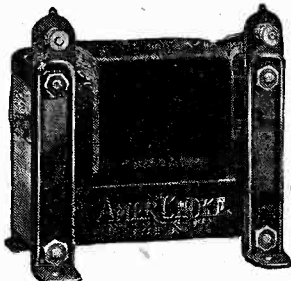

The AmerChoke
Type 854

This is a scientifically designed impedance or choke coil of general utility, designed primarily for use in filter circuits. As an output impedance for by-passing direct current from the loud speaker it is both efficient and economical.



AmerTran Types AF-7
and AF-6

AmerTran Audio Transformers, types AF-7 and AF-6, have been considered for years among the leaders in audio amplification. These popular and efficient models are made in two types—AF-7 (ratio 3½:1); AF-6 (ratio 5:1).

The AmerTran Code

In radio it is useful to look beyond the product to the organization responsible for it. There will be found the ideals and the experienced skill which won a reputation and added to it year after year.

AmerTran radio products carry a name that is known wherever transformers have been used, from Marconi's first trans-atlantic wireless to the marvelous fact of today in sending the voice over thousands of miles of ocean and land. The manufacturer of AmerTran Products has a reputation for making *only* fine quality units, which, when subject to fair comparison, have proved their merit always.

This manufacturer has never misrepresented his products, their uses, or state of perfection. Solely on the basis of accomplishment has been earned the endorsement of the radio trade and the radio public.

This manufacturer will continue to offer dependable, well-designed and well-made products. Never will it be claimed that they are faultless or the ultimate. That would ridicule the efforts of those who are always turning the good article of today into the better article of tomorrow.

On this code is based the manufacture and sale of AmerTran Radio Products.

American Transformer Co.

178 EMMET ST.

NEWARK, N. J.

"Transformer Builders for over 26 Years"

Pacific Coast Office

Rialto Building, San Francisco

Tell them that you saw it in RADIO

*Long prophesied
Often attempted
Makeshifts frequently employed
Here at last!*

CROSLLEY Radio Energy

*with only a
switch to snap*

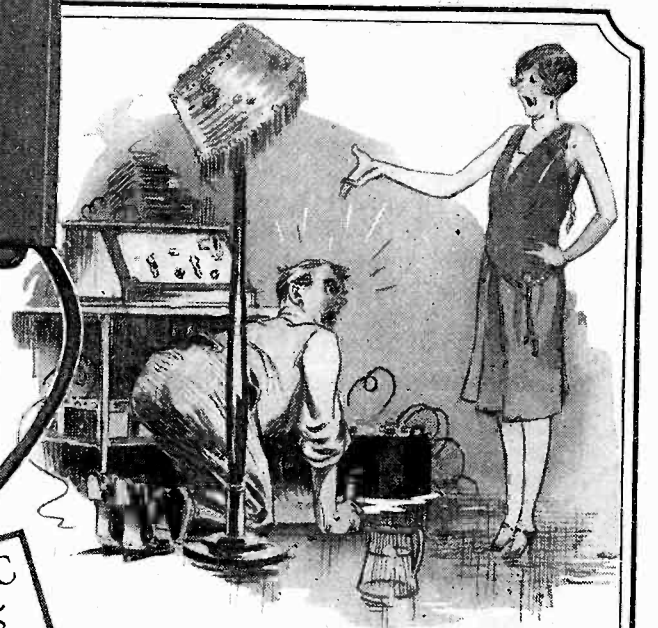
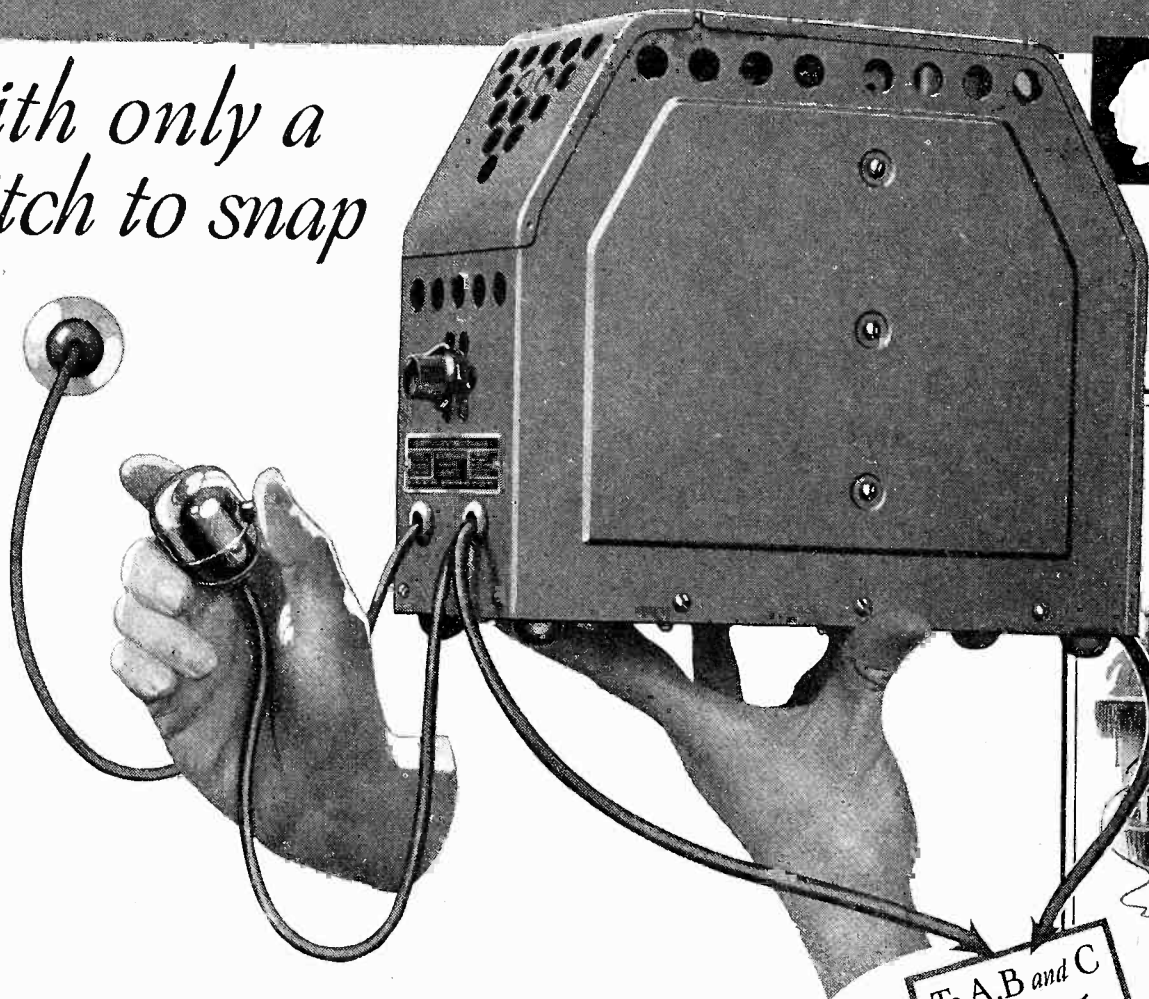

To A, B and C
Binding
Posts

A, B and C Radio Power

from house current outlet direct into your radio with no more attention or thought than you bestow on a vacuum cleaner or your electric iron. This wonder box weighs only 13 lbs., stands 9 inches high and is 4 inches wide and is about half the size of an ordinary A storage battery. It is a mechanical device transforming ordinary 110 volt 60 cycle house lighting power into smooth, quiet radio energy for the new Crosley radios without slightest interfering hum and with the certainty of an electric motor. Price **\$50**

Crosley radios designed for use with this marvelous power supply are the AC-7, a 6 tube table model at \$70, and the AC-7-C, a 6 tube console at \$95. See these wonderful sets at any Crosley dealers, or write Dept. 19, for descriptive literature.

Crosley sets are licensed under Armstrong U. S. Patent No. 1,113,149, or under patent applications of Radio Frequency Laboratories, Inc., and other patents issued and pending.

THE CROSLLEY RADIO CORPORATION

CINCINNATI

Powel Crosley, Jr., Pres.

OHIO

Tell them that you saw it in RADIO

No batteries to fuss with.
No more batteries or battery
charger to water.

No failure of the power plant just
as you sit down to a fine program.

No batteries to recharge.

No batteries to renew.

No apologies to make to callers
because "the batteries must be
getting low."

No upsetting the house to have the
radio serviced.

NO MORE annoyances from the
vital power supply end of your
radio. A snap of the switch is
the only demand your radio makes
upon you from NOW ON.

Through this man's invention the Musicone revolutionizes the loud speaker field

Powel Crosley, Jr.



Prices slightly higher west of the Rocky Mts.

CROSLY RADIOS \$29 to \$98

NOW!
 The Genuine
CROSLY MUSICONE
\$9.75
 16 inch size . . . \$14.75

C. A. Peterson, only 24 years old, is responsible for the amazing tone, the surprising volume and the startling fidelity of reproduction of the Crosley Musicone.

Nearly three years ago a shy and reticent young man walked into the office of Powel Crosley, Jr., with an idea for a radio loud speaker under his arm. When he unwrapped the newspaper around it Mr. Crosley instantly saw its great possibilities.

Mr. Crosley offered him the equipment of his laboratories, the assistance of his engineers and the resources of his company.

In a short time Peterson produced a marvelous actuating mechanism so designed as to vibrate freely without choking regardless of the heavy electrical impulses applied to it. It revolutionized the loud speaker field.

Within a few weeks after its announcement the Musicone captured the loud speaker market and has dominated it ever since. Horns with their ugly appearance and their harshness of reproduction which so discredited radio in early days were promptly obsoleted.

The Musicone has been imitated in appearance but the patented actuating unit has never been equalled. Incidentally Mr. Peterson's royalties on this instrument have been over \$90,000.

Attached to a good radio the Musicone delivers pure, true tones, without distortion regardless of how suddenly the crashes of orchestra or high shrill notes come through it. As an ornament its rich bronze frame and the quiet tones of its ornamental cone are an addition to the decoration of any room. Made in two sizes and at two prices without any difference in quality.

The 12-inch Ultra Musicone for small rooms, apartments, etc..... \$9.75

The 16-inch size Super Musicone for large rooms or porch use..... 14.75

THE CROSLY RADIO CORPORATION
 CINCINNATI, OHIO
 Powel Crosley, Jr., Pres.

Write Dept. 19 for descriptive literature.

CROSLY
MUSICONES

Tell them that you saw it in RADIO

New 32-Page
Booklet Giving
Information
Usually Known
to Expert Set
Builders.



(Continued from page 48)

you've got us into this scrape, you're not going to back out because you see a little mud doll. You're going to come with us to the town when we get ready and interpret what we say to these heathen. Come on!"

Half dragging Juan, Bill strode toward the idol. "Like to explore it," he explained mysteriously, and I could see that he had some new idea. "It may help us to get some grub from these folks."

Juan began to plead with us. "No! No! Those idol ees bad Aztec debbil god. He will keel us dead!"

"He will, huh?" Bill calmly produced a piece of cord and tied Juan's feet and hands. "Can't take any chances on our nice mouthpiece running away," he explained to me.

Leaving Juan flopping miserably on his back we strode over to the idol and looked it over.

"It's hollow," murmured Bill after a moment. "I wonder—yes, here's a hole around in back where we can get into his insides. Gosh—dusty as the dickens in here!"

He crawled in, and after a few moments of muttering exploration in the digestive regions of the old god he emerged with a triumphant air.

"It'll be fine," he assured me. "Just like it was made for our purpose. Even got a hole in his mouth to let the sound out good."

"Sound?" I stared at him. "Why in blazes do you want a hole to let the sound out of a dumb idol like that?"

"Hum." Bill smiled at me patronizingly. "It is dumb just at present, isn't it?"

"Not half so dumb as you," I returned, beginning to mad. "Why are you wasting time around this thing when we're starving to death within sight of food?"

"Don't get to talking about the Old Boy," said Bill, familiarly patting the idol on one of his grotesque feet. "If I'm not greatly mistaken he is the one who is going to get our food for us. I have an idea that he will get us about anything in town if he is managed right."

"Managed? Good night, Bill! Do you mean to say that you are going to persuade that confounded hunk of ancient sculpture to walk down to the village and get us a load of grub?"

"No." Bill untied Juan and helped him to his feet. "We'll just ask him to give a sort of vocal recital for the natives: and if the dear folks are anything like what I think they are they'll be perfectly willing to bring us enough supplies to take us to Europe. We'll have to interview the villagers, though, before it will work."

In less than an hour we were sitting

in the adobe mansion of the village mayor, or whatever they call him. He was a greasy sort of customer, and the abode of a dozen skunks would have been a perfumed dream beside the odor of his house. However, we were relieved to find that we could communicate with him fairly well through the aid of Juan's interpretation. Bill fished around for a while until he got some data on the idol—the amount of respect they had for it, its name, (which I couldn't pronounce) and several other things that I couldn't see his purpose in learning.

"He says that the Old Boy is a great devil god. The people won't go closer than a hundred yards to him, although they all have to go once a day and make a prayer," explained Bill to me in an excited undertone.

"Look here, Bill," I said to him. "I've had enough of this gab about idols and prayers. Tell the old greaser that we want something to eat, and pretty darn quick! I haven't had a bit since last night."

Bill gave me a scathing look. "Al," said he, "I am running this party and you keep your nose out. I know how to handle these birds and you don't. Ask him for food—the old man would probably slit all our throats and throw us to the hogs! He's already suggested that all visitors should make a substantial gift to the chief man of the village—which is himself. This is the place where strategy is demanded, and I am the one who is going to show it."

Turning to Juan and the old chief Bill began dictating again.

"Tell him," he said slowly to Juan, "that we are the sons of the idol up there. Tell him that we are going on a journey, and the Old Boy sent us to him to get fresh supplies."

"Madre de Dios!" Juan rolled his eyes in terror. "Eef I talk that, those beeg idol god will keel me dead!" His face had turned a pasty green with fright.

"You say just those words," Bill ordered grimly, "or those beeg idol god won't have a chance at you. I'll slit you up in little thin strips and hang you about on the bushes!"

Juan shut both eyes, crossed himself devoutly, and delivered the message to the chief. No sooner had he got the words from his mouth than the old man shrank from us as though we were snakes. Then he jumped up and began jabbering wildly.

"He say you are not so! He say you are tell heem beeg lie!" Juan stuttered in his terror.

For my part I was ready to admit it and clear out, but Bill strode toward the old chief with a terrific roar.

"Obgoobligdook!" he shouted, waving his fist in the old chap's face. Bill

Just off the press!

Every radio set contains from one to a dozen fixed condensers. Do you know what they are for? Do you know how to test them to see whether they are working properly? Do you know that there is a way of changing the range of your tuning condensers?—of getting greater selectivity—of improving the tone? All through simple applications of fixed condensers.

The Dobilier Condenser Corporation is now supplying radio fans with a complete and authoritative explanation of the correct use of fixed condensers.

You have often envied the man who could look over your set and by inserting a small fixed condenser somewhere, greatly improve its tone and operation. Do this yourself. Perhaps some defect in reception that you have always thought could not be helped is due to an imperfect condenser.

This new booklet will also give you the most recent information on power amplifiers, filters and battery eliminators. Send 10 cents in stamps or coin for your copy.

Dobilier

CONDENSER CORPORATION

4377 Bronx Boulevard, New York, N.Y.

Tell them that you saw it in RADIO

didn't know any foreign language, but that word had its effect. The ruler of the village staggered back, awestricken. He seemed to kind of collapse in his chair, but when he began talking again his courage returned. Bill stopped him with another wave of his fist. "Igdig-doolickner!" he yelled.

"Now tell him," he said to Juan, "that we will give him proof of our relation to the god. If the people will come out to the idol at sunset, we will ask the Old Boy to sing for them."

"Sing? Those idol sing?" Juan was getting interested.

"Tell him," ordered Bill.

"Now tell him that we want some food to put the Old Boy in a good humor for his concert."

Juan looked rather puzzled, but finally got the idea across, and after more grumbling the old man had brought out some squatty little tamale things and a big bowl of beans. We took them with many haughty gestures and receded up the street toward the idol.

"Now," I said to Bill as soon as we were outside the city limits, "look what you've let us in for. We've got to make that idol sing this afternoon, or we're through in this campaign."

"Ug-huh," gurgled Bill, cramming down a hunk of tamale and drinking a pint or so of beans. "Yeh." He eyed the tamale approvingly. "Not so bad," he said, "after living on thimble berries and water for forty-eight hours."

I gave him a disgusted look. It was plain that he had gone nuts; but those tamale things were better than nothing, so I decided to lay off him for the present. About two hours from sunset we arrived at the old idol. Bill hitched Juanita's rope to one of the god's toes and immediately began unpacking the radio set and all his old spare parts. I'm no dumbell, and I began to see light.

"Oh," I said, "you expect to pick up some music and broadcast it through the thing's mouth, I suppose?"

"Blug-huh," answered Bill in an explanatory tone from under Juanita's stomach where he was engaged in uncinching the pack. "Don't know as you'd hardly call it music, but we'll do our best."

"But suppose you can't pick up anything broadcasting," I said skeptically. "We're a long ways from home, and we'll have good luck if we can pick up even enough static to make an audible buzz."

"Huh!" grunts Bill, with a secretive grin. "We'll pick up something all right. The Old Boy will sing, too!"

He had got the whole radio kit, spare parts and all, unpacked and on the ground. As I mentioned once before, Bill was once a radio amateur, and he had a lot of extra junk along. From the heap he extracted an old telephone transmitter and a long piece of double-

(Continued on page 51)

DIRECT FROM FACTORY TO YOU

Western "B" Power Unit

Ample power for 171 tube.

Two voltage controls.

No hum.

No distortion.

Full wave rectification.

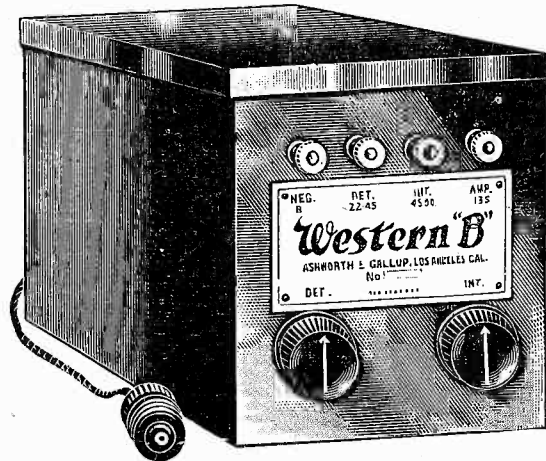

180 VOLTS

\$18.50

Why be troubled with batteries when you can now buy a guaranteed Western "B" Power Unit for less than half the price of others.

The Western "B" Power Unit is a quality product throughout, made of the finest materials, absolutely guaranteed to give complete satisfaction or money refunded.

OPERATES ANY SET FROM THE LIGHT SOCKET.
LIKE HAVING NEW BATTERIES EVERY NIGHT.

Mail the Coupon Today

Shipped same day order received.

Tested and Approved for the IN-FRADYNE by the laboratory of "RADIO" magazine.

ASHWORTH & GALLOP,
5845 S. Broadway, Los Angeles.

Gentlemen:—Please send me at once one Western "B" Power Unit. If after seven days' trial it is not satisfactory, I will return it and you will refund my money.

Payment Enclosed, \$18.50.
 Send C. O. D.

Name.....

Address.....

City..... State.....

demand
AEROVOX
"Built Better"
FILTER CONDENSER BLOCKS

*for all "B" Eliminators and Power Amplifiers
AEROVOX products are used as standard equipment by over 200 manufacturers of Radio Receivers and "B" Eliminators.*

AEROVOX WIRELESS CORP.
60-72 Washington St., Brooklyn, N. Y.



A Message to Manufacturers

Today, buyers of radio—receivers, battery eliminators and power amplifiers—insist upon the latest of approved designs and finest quality of performance. To you, the manufacturer, much depends upon your source of supply on parts.

For audio amplification, power amplification and battery elimination the very latest designs are found in Dongan Transformers. Exclusively a manufacturer of high-grade parts Dongan offers the newest improvements in engineering ideas and the extreme quality in construction—at a price within your purchasing requirements.

Allow us to help you to improve your product.

Dongan Electric Manufacturing Company
2981-3001 Franklin St. Detroit

TRANSFORMERS OF MERIT FOR FIFTEEN YEARS

Tell them that you saw it in RADIO



wherever a variable resistance is specified

pin your faith on CLAROSTAT, the greatest variable resistor. CLAROSTAT has met every exacting requirement of the country's leading manufacturers, technicians and radio engineers and is now standard equipment in the products of 90 per cent of the B eliminator manufacturers of the country.

CLAROSTAT alone covers the entire range—from practically zero to 5,000,000 ohms and a current carrying capacity of 20 watts without the slightest trace of packing, arcing or frying noises.

Going fast! The first edition of "The GATEWAY TO BETTER RADIO" is almost exhausted. Send for your copy at once, 32 pages covering everything in Radio. Send 25c to Dept. P. R.

American Mechanical Labs., Inc.
285 North 6th St., Brooklyn, New York City



CLAROSTAT

TOBE

Radio Interference Filter No. 1

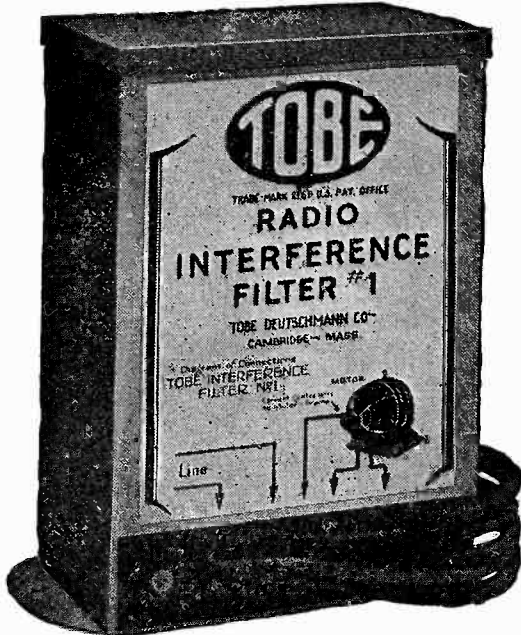

is made for attachment to household motors and appliances, up to 1/4 H.P., such as oil burners, refrigerators, sewing machines, vibrators, etc. Its design incorporates means for prevention of damage to commutators, which may occur when condensers only are used.

Provided with five leads so that no extra wiring is required for attachment. A simple wiring diagram is printed on the label. PRICE, \$18.00

Write for special descriptive pamphlet P-3

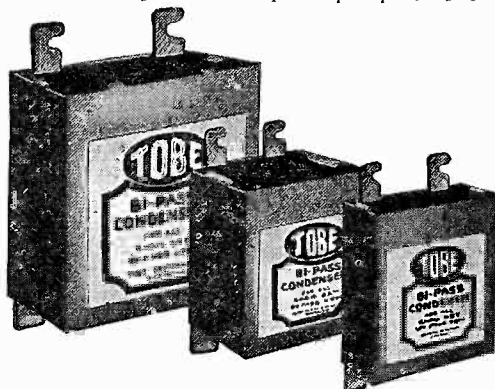

Tobe Filter and Bi-Pass Condensers

Standard wherever Radio is found. They are specified by Arthur H. Lynch and James Millen in the National Lynch Power Amplifier. Radio Listeners Own Set—Shielded Highboy Super, Bruno Set, Samson DeLuxe Set, Alden Somerbridge Circuit, Hi-Q B-Eliminator, R. B. Lab. Set, Lincoln Super, Ultra-5. Used as standard equipment by National Company, General Radio Company, Philco, Modern, Storad, King Radio, and many other leading manufacturers.

Ask your dealer to show you the new TINY-TOBE. A new process little condenser—capacities .0001 to .02.

TOBE DEUTSCHMANN CO.

Engineers and Manufacturers
Cambridge Mass.

Valley
"B" Power Unit

Manufactured by
VALLEY ELECTRIC CO.
ST. LOUIS, MO.

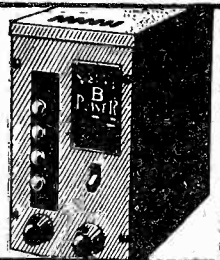

KARAS EQUAMATIC MANUAL
Price 10c.

Build the Karas Equamatic 5-Tube Radio Sensation—the most selective receiver ever designed. Mail 10c today for 16-page Manual of wiring diagrams and complete instructions for building this remarkable receiver. Address:

KARAS ELECTRIC COMPANY
1049 Association Building Chicago, Ill.

(Continued from page 50)

strand wire. Hitching this wire to the loudspeaker of his set he disappeared into the entrails of the old god with it. In a minute I heard a muffled voice calling me from the front of the idol, and going around I saw Bill's hand protruding from the Old Boy's mouth. It waggled for my attention, and then Bill began a series of vocal exercises in the interior of the idol.

"Blah-bloo-blah-Gosh-Darn-Al—does the sound come out all right?"

"Comes out!" I told him. "Whether it's all right is another horse of a different plumage."

"Fine!" he shouted down.

In another minute he came backing out the god's rear entrance, but without the loudspeaker. That, he told me, was parked up in the Old Boy's nasal cavities. "And now," he said, "I'll get to work."

He grabbed the radio set and the loudspeaker wire and trailed down to a little gully about fifty feet to one side of the idol. There he fixed the radio set securely on the ground and began tinkering with it. As he tinkered, he explained to me.

"Of course you don't know anything about radio sets, Al," he said as he connected the loudspeaker wire to some binding posts. "But this set has two stages of audio amplification. That means that two of the tubes are fixed to amplify radio waves which have already been changed to audible sounds—the kind you can hear with human ears. Now, if that is so, why can't I shoot my voice into this set and have it amplified enough to make that loudspeaker squawk up there?"

"Er-hem," I acknowledged carefully. "I see no reason why you shouldn't—if you can shoot your voice into the set."

"I can," said Bill. "Toddle up there to that pack and bring me that old telephone transmitter, will you Al?"

When I had brought it, he took a couple of short wires and connected it some way to the interior of the set. "Just hooked it onto the two audio tubes," he explained. "The detector can't help any."

Carefully he went over the impromptu wiring; then hooked on the batteries and turned on the rheostats.

"Now Al," he said, picking up the telephone mouthpiece, "go up in front of the Old Boy and listen. I want to try out his voice, but I don't want to talk loud enough for all the natives to hear."

I slunk up in front of the idol and sat down on the grass. Juanita was grazing sleepily about his feet. Presently, from somewhere in the air above me, came a faint, sighing whisper. "Whoo-oo-oosh" It faded away over the hill. Juanita suddenly stopped grazing and lifted her ears uneasily toward the god's gaping mouth.

Tell them that you saw it in RADIO

"Al," came the ghostly voice again, this time a bit louder, "Al—prepare to die!"

It was uncanny. The sound was coming from the idol's mouth. I could almost see his mud eyes move.

"Al," said the voice again, this time loud enough to be heard a block, "Al—the end is here!"

With a terrific blast of sound a hoofed demon seemed to spring directly from the bowels of the old idol. I felt a staggering impact of a soft body against mine, and rolled over in the grass just in time to see Juanita galloping away over the hills like a thousand devils were on her tail. She had darn near broken my arm as she hit me!

Bill came around the corner, and he was grinning like a kid with an all day sucker.

"Works, doesn't it, Al," he chuckled.

"Works!" I bellowed. "Works? You crazy lunatic. Do you know what you've done? You've scared away our Juanita—the pride of our hearts, the pack-burro of our grub! We'll never catch her now. She won't stop this side of Los Angeles. And there's a fat chance of us getting another burro from these folks!"

"Don't let that worry you, Al," Bill comforted me. "I think they'll be glad to let us have all the burros we may need."

"Don't deceive yourself, dearie," I snarled back. "They're not going to get so terribly generous just because you get up there and whoop around through an old god's nose!"

"Generosity has nothing to do with it," Bill informed me coldly. "But suppose, while the entire populace is sitting around listening to the Old Boy's recital, we depart with a well loaded pack train. They can't help being generous."

"Yes. But as soon as you quit broadcasting through that mud baby, the party will break up and they'll be about our ears before we have time to clear out."

"Admitted," said Bill. "But we aren't going to quit broadcasting until we're crossing the faint horizon. There's a good trail out the north end of the valley. Saw it as we came down."

"But who's going to hold the microphone in your absence?"

Bill nodded casually toward the parrot, dozing lazily in his cage. "Captain Flint," he introduced. "Chief announcer of M-U-D."

At the sound of his name, the bird shifted on his perch and fastened one eye evilly on Bill. "Shut your darn mouth!" he croaked. "Shut y'r darn mouth!"

Bill grinned. "Come on Al," he said. "Let's go down and cast an eye over that flock of grazing burros. We want the best there is when we select ours."

(Continued on page 54)

USE THESE COILS AND IMPROVE ANY RADIO RECEIVER

AERO COIL

SUPER-SENSITIVE

INDUCTANCE UNITS



TUNED RADIO FREQUENCY KIT
\$12.00

The Aero Coil Tuned Radio Frequency Kit illustrated above will positively improve the performance of any receiver. Patented Aero Coil construction eliminates radio frequency losses and brings tremendous improvement in volume, tone and selectivity. Kit consists of three matched units. The antenna coupler has variable primary. Uses .00035 condenser. 8 page color circuit, layout and instruction sheet for building the supersensitive 5 tube Aero-Dyne receiver packed FREE with each kit. Extra copies, 75c each. Instructions include insert showing how to wire up for a power tube if desired.

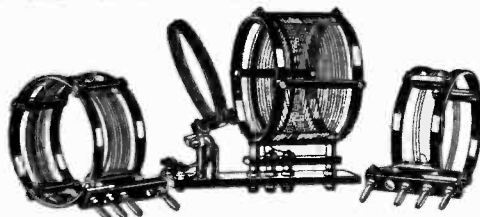

LOW WAVE TUNER KIT
\$12.50

Completely interchangeable. Adapted by experts and amateurs. Range 15 to 130 meters. Includes three coils and base mounting, covering U. S. bands, 20, 40 and 80 meters. You can increase the range of this short wave tuner by securing coils Nos. 4 and 5. Combined range of 15 to 550 meters. Both interchangeable coils fit same base supplied with short wave kit and use the same condensers. Coil No. 4, price \$4.00; Coil No. 5, price \$4.00.

Get these coils from your nearest dealer. If he should be out of stock, order direct from the factory.

AERO PRODUCTS, INC.

Dept. 103, 1772 Wilson Avenue, Chicago, Ill.

(Pacific Coast Representative)

HENGER-SELTZER

1111 Wall St., Los Angeles, Cal.
377 Brannan St., San Francisco, Cal.

C. E. GAY

449 Alder St., Portland, Ore.

Bradley-Amplifier

Resistance-Coupled
PERFECT AUDIO AMPLIFIER

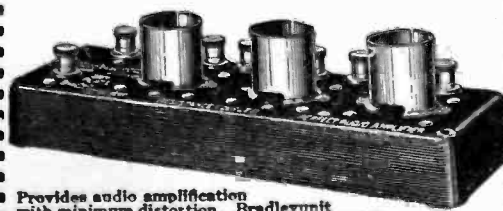

Provides audio amplification with minimum distortion. Bradley unit golded resistors used in the Bradley-Amplifier do not vary with age and are not affected by atmospheric conditions. Can be used to replace transformer amplifiers in standard radio sets with decided increase in tone quality.

Allen-Bradley Co.

Electric Controlling Apparatus
279 Greenfield Avenue Milwaukee, Wis.

Potter Condensers

Potter condensers, American made of highest quality materials to full capacity, build the best Socket Power Devices, Power Amplifiers, Impedance Amplifiers. And they are best for Filter Uses, Rectifiers, By Pass, and Blocking D.C. All types and sizes.

POTTER MANUFACTURING CO.
North Chicago, Illinois

LOG THOSE STATIONS

10c

For A Handy Pamphlet
"RADIO"

433 Pacific Building

San Francisco

Tell them that you saw it in RADIO



Oh boy
KESTER
 Rosin Core
Radio SOLDER
 Sure is Safe and Simple

Approved by
Radio Engineers
 A Genuine Solder
 CHICAGO SOLDER COMPANY
 4254 Wrightwood Ave., Chicago, U. S. A.

Originators and
 World's Largest Manufacturers of
 Soft Fluxing Solder
 100% PURE
 AN SUPPLY CO.

ACME

**FLEXIBLE
 CELATSITE**

Flexible, stranded wire for point-to-point and sub-panel wiring. Non-inflammable "spaghetti" covering. In black, yellow, green, red and brown; a color for each circuit. Put up in 25-foot coils.



The Original Celatsite

—a tinned, copper bus bar wire with non-inflammable "spaghetti" covering, for hook-ups. 5 colors; 30-inch lengths.

Celatsite Battery Cable

—a silk-covered cable of vari-colored Flexible Celatsite wires, for connecting batteries to set.

Prevents "blowing" of tubes; gives your set an orderly appearance.



We also offer the highest grade of "spaghetti" tubing for Nos. 10 to 18 wires. 5 colors; 30-inch lengths.

Stranded Enameled Antenna

Best outdoor antenna you can buy. 7 strands of enameled copper wire; maximum surface for reception. Prevents corrosion and consequent weak signals.

Send for folder

**THE ACME WIRE CO., DEPT. R
 NEW HAVEN, CONN.**

ACME WIRE

MAKES BETTER RADIO

BUILD THE NEW, SHIELDED

Hammarlund

ROBERTS

HiQ

RECEIVER

Send 25c for Construction Book

Hammarlund-Roberts, 1182-F Broadway, N.Y.

Standard



Specified by leading engineers in all popular circuits as the one perfect form of tube filament control. Insist on Amperite—the only automatic variable filament resistance. Beware of substitutes and imitations. There is only one Amperite and nothing else will do. Eliminates hand rheostats. Simplifies wiring. Types for all tubes. Price \$1.10 mounted (in U. S. A.). At all dealers. Write for Free Hook-Ups and construction data to Dept. R-3

Radiall Company
 50 FRANKLIN ST., NEW YORK

AMPERITE
 REG. U. S. PAT. OFF.

The "SELF-ADJUSTING" Rheostat

YAXLEY
 APPROVED RADIO PRODUCTS

Automatic Power Control



The Yaxley Automatic Power Control does all the extra switching for you. No more plugging in sockets and turning switches every time you use your set—no more tinkering with them every time you turn off the set. The Yaxley Automatic Power Control takes care of your B eliminator or trickle charger or both. You know that when you turn on your set, the trickle charger is off, the B eliminator is on. When you turn the set off the power control is standing guard for you, automatically, surely and without fail, turning off the B eliminator and on with the trickle charger.

No. 444 Automatic Power Control, Series Type—for use with sets having tubes with a current draw equal to or greater than 6 U.V.-199 type of tubes Each, \$5.00



Also makers of Famous Air Cooled Rheostat, Jacks, Jack Switches, Cable Connector Plugs, etc.

At your dealer's. If he cannot supply you send his name with your order to

Direct Representatives:

HENGER-SELTZER CO.

1111 Wall Street..... Los Angeles
 377 Brannan Street..... San Francisco

D. H. BURCHAM

1553 E. Everett Street, Portland

YAXLEY MANUFACTURING CO.

Dept. A, 9 So. Clinton Street
 Chicago, Ill.

(Continued from page 53)

AN hour before sunset the grandstand (figuratively speaking) was full, and from the size of the crowd spread out over the plateau before the idol I figured that everybody in town had come to church. After making a hasty scouting trip through the village I found that I was right. The place was utterly deserted.

Returning to Bill's broadcasting studio in the gully, I informed him of conditions and we laid our plans. As the audience seemed to be complete, Bill said he guessed we might open the service. I wanted to see how things progressed, and so I sneaked up behind a bunch of trees where I could see the crowd.

Gesticulating wildly, the villagers were directly before me. I could see, however, that they had an evident respect for the old idol. They kept their distance from his feet and their glances toward him were frightened and sullen. The village chief sat in the front row, his black eyes blinking excitedly in his pudgy, evil face.

As I watched, a faint whoo-oo-sh came from the idol's mouth. A kind of startled sigh went shivering through the mob, and I knew that we at least had their undivided attention. They sat still as petrified mummies. A faintly mournful wail floated through the air and quavered out over the trees. This, I knew, was Bill's preliminary warming up exercise; but it went over great with the crowd. Some of the people fell on their faces with their hands over their eyes. Most of them were too interested to fall.

And then Bill began his singing! It was wierd enough—almost ghastly at times. Bill is not a singer. First he gave a verse of "Barney Google," and I could see with my nude eye that the crowd was greatly affected. Then followed, in rapid succession, snatches of "Collegiate," "Sleepy Time Gal," and "The Star Spangled Banner."

By that time most of the natives were on their faces flopping around and squawling for mercy I suppose. A few of them, however, were still upright and defiant. But as the first five words of "Aggravating Mama" boomed over the hills, they flopped and began squawling with the rest.

I skipped down into the gully and got there just as Bill was enthusiastically starting in on the second stanza of "Oh How I Miss You Tonight!" When he heard my report he suspended operations.

"Al," he directed me, "Captain Flint's cage is over there under that brush. Get him out, and bring him over here to the microphone."

Having nothing better to do, I did as directed. The bird was in the middle of his nap, and set up a fearful squawk-

(Continued on page 54)

Tell them that you saw it in RADIO

THE Simplicity of tuning
THE Efficiency of the Bakelite Shaft Condensers
 and Quatzite Coils
and the Beauty of the Bronze Front Plate



Makes the
"UNITUNE" the most
 desirable tuning device
 ever designed.

**ALL BRUNO
 "UNITUNES"**
 may be mounted on a
 panel with only two
 screws.

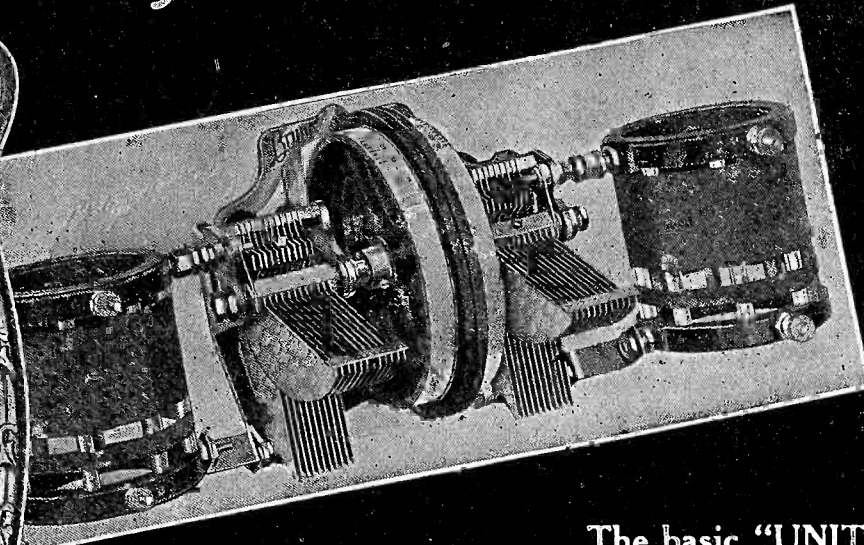
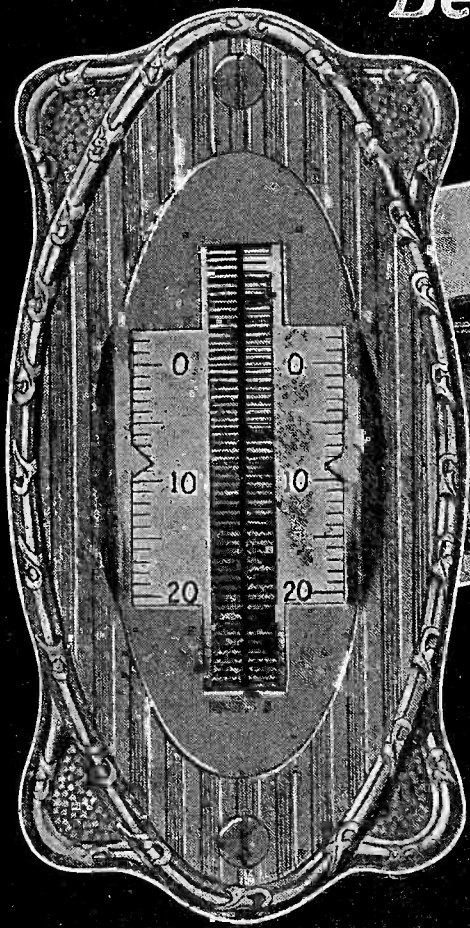

The basic "UNITUNE" consists of a frame upon which are mounted two condensers operated independently by two bakelite drums projecting thru a beautiful bronze plate. It may be obtained in all standard capacities. Completely assembled it lists at \$11.00.

Other "UNITUNES" assembled with one or more Quatzite Coils for all popular circuits range from \$12.00 to \$21.00.

Booklet of Instruction and Blue Prints—25¢

BRUNO RADIO CORP., LONG ISLAND CITY, N. Y.

HERE IT IS!
Marvelous Townsend
"B" ELIMINATOR
 (Complete)

only 495
 \$1.00 down
 Balance COD.

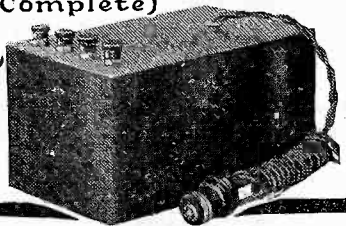

Direct From Factory at Lowest Price on Record

Great news! For half the price of a set of "B" batteries you can now enjoy greatly improved reception and be done with unreliable "B" batteries. We make the Townsend "B" Eliminator complete in our own factory. That's the reason we can give you at such a remarkably low price a high quality instrument backed by a real guarantee. Users report splendid results. A fine "B" Eliminator at the lowest price on record. Our 10 days Free Trial proves it.

10 Days FREE TRIAL
 You are the Judge!

MONEY BACK If Not Amazed and Delighted

You alone are the judge. We could not afford to make this guarantee if we were not sure of the Townsend "B" Eliminator's splendid performance. Delivers up to 100 volts on any set up to six tubes, on direct or alternating current—any cycle. Gives full wave rectification. Full tone, clarity and volume.

Rush Order Today Simply put your name and address on a piece of paper, pin a \$1 bill to it and get it into the mail at once. Your "B" Eliminator will be sent you promptly. Deposit \$3.95 only with the postman. Try out for ten days—then if not thrilled by improvement in operation, return Eliminator to us and purchase price will be refunded in full. You don't need to put up with battery nuisance another day when it is possible to own a "B" Eliminator at this startlingly low price. Send for it today.

Townsend Laboratories, 713 Townsend St., Dept. 18, Chicago, Ill.

COILS MATCHED

Radio frequency coils accurately matched for Infradynes and other sets. What a difference this makes. Only 35 cents per coil. Send them to **LABORATORY of "RADIO,"** Pacific Bldg., San Francisco. We also are in a position to purchase these coils for you.

**INFRADYNE
 MANUALS**
25c PACIFIC RADIO
 PUB. COMPANY
 SAN FRANCISCO.

Lowest Wholesale/Prices

**ULTIMAX KITS
 NOW READY FOR DELIVERY**

Madison Multi-Chokes, Cockaday LC-27, R. B. Lab., Hammarlund-Roberts, Alden Tru-phonic, Amer-Tran Power Packs, LR-4, Infradyne, Benjamin Controlladyne Kits in stock.

**JOBBER-DEALERS
 PROFESSIONAL SET BUILDERS**
 Before buying, get our quotations on our Guaranteed Kits. 3-Hour Shipping Service.

1927 BUYING GUIDE
 A few copies left for Dealers and Professional Set Builders. Send for yours today. It's free! Address Dept. R.

We are the exclusive direct representatives of the Committee of 21 Manufacturers.

Allen-Rogers
 Incorporated
 Kit Headquarters
 118 East 28th St., New York, NY



Pat'd.
 5-2-'16
 7-27-'26

Licensed by
 Rider Radio
 Corporation

**R. F.
 Oscillation
 Conquered**

"Phasatrol"

A true balancing device for radio frequency amplifiers.

If your set squeals or oscillates you need PHASATROLS.

If you are building a new set, and want the last word in electrical efficiency—equip it with PHASATROLS.

PHASATROL is the latest development in the field of radio frequency amplification. As a balancing device, it is far superior to any other methods heretofore in use for suppressing oscillations in the radio frequency amplifier circuit. It is being used and endorsed by leading radio authorities.

At YOUR dealers or write direct. Write for Hook-up Circular.

Price, \$2.75

175 Varick Street
 Dept. 26, New York



ELECTRAD



Tube Tester— for the set owner

By using a Jewell Junior Tube Checker you can test your radio tubes at home and keep an accurate check on their condition. One poor tube will easily ruin otherwise good reception.

The plug attached to the tester is inserted in the socket of the tube being tested and the tube placed in the tester. With the filament rheostat of the set turned on to the normal position, readings are taken on the milliammeter on the tester, which will give a direct indication of the tube condition. The universal socket with adapter and plug permit testing of all types of tubes.

Write for descriptive circular No. 735

Jewell Electrical Instrument Co.
1650 Walnut Street Chicago
"27 Years Making Good Instruments"

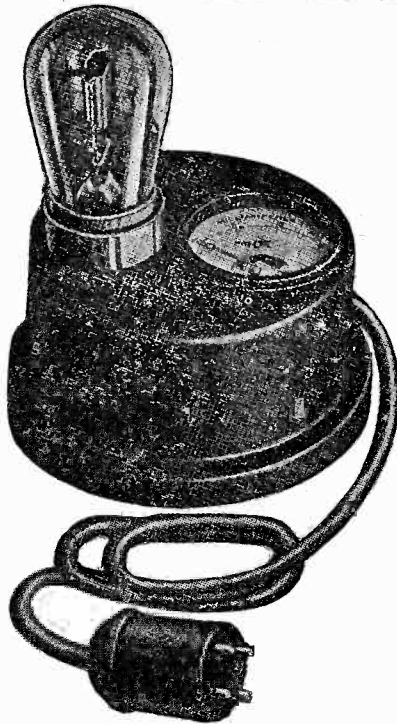

Pattern No. 107—
Jr. Tube Checker
gives a direct indication of
the condition of the tube.

(Continued from page 54)

ing and jabbering the moment I waked him. Bill grinned as I came back.

"Squawk away, you green eyed fool!" he chuckled to the parrot. "The louder you shriek, the better we like it!"

With a piece of shoestring he tied the bird closely to the microphone. "According to previous calculations," he said, "it will take him about three hours to chew through that string and get loose. Meanwhile he'll raise an awful row. Three hours ought to give us a good start."

"Shut your darn mouth!" screamed Captain Flint, clawing angrily at the microphone. "Shut your darn mouth!"

His raspy voice boomed out through the idol's mouth like the roaring of a giant.

"All right, old buzzard," Bill told him comfortingly. "Just so you don't shut yours."

In the deserted village we caught three husky little burros, and after rigging up some packs of beans, corn, and jerked meat which we discovered, we set out rapidly for the north and home.

On the northern rim of the valley, before we started down the well worn trail before us, we paused to look back. The last rays of the setting sun were sliding over the village, and the monstrous idol on the mountain side was covered with a kind of brilliant, golden halo of light. All about his feet, prone in the dust, were the villagers. Through the clear air came their feeble, monotonous wailings. As we watched, the shadow of the mountain crept up the old god until only his tusked head was glowing in the light, like a golden ball of fire.

Of a sudden a wild shriek reverberated through the valley, followed by a raspy, inhuman voice.

"Pieces of eight! Pieces of eight! Shut your darn mouth!"

The voice took on a softened tone: "Polly wants a cracker. Poor Polly. Poor-r-r Polly!"

Bill smiled softly. "I hope that shoestring holds for a couple more hours," he said as we turned and plunged down the trail.

NEW

MUTER

Dependable Products

—for the 1927 Season

Muter Products
Are Distributed to the
Western Jobbers by

A. S. Lindstrom Co.
SEATTLE—PORTLAND
SAN FRANCISCO—LOS ANGELES
SALT LAKE

Leslie F. Muter Co.

76th and Greenwood Avenue
CHICAGO, U. S. A.

Knife Throw Switches

Moulded Bakelite base—Spring
brass contact—Moulded insulated
handles.



Single Pole, Double Throw
Base 2 1/4" x 1 1/4"
Stock No. 2010.....70c list



Double Pole, Double Throw
Base 2 1/4" x 1 1/4"
Stock No. 2020.....\$1.00 list



Triple Pole, Double Throw
Base 2 1/4" x 2"
Stock No. 2030.....\$1.50 list

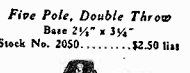

Five Pole, Double Throw
Base 2 1/4" x 3 1/4"
Stock No. 2050.....\$2.50 list

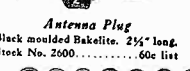

Antenna Plug
Black moulded Bakelite, 2 1/4" long.
Stock No. 2600.....60c list



Resistance Amplifiers
Completely wired, ready for installation. Individually packed, with instructions.
Stock No. 1410 (2 stage).....\$6.00 list
Stock No. 1400 (3 stage).....8.00 list

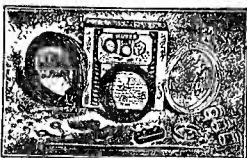

Standard Complete Aerial Kit
Contains all necessary parts to erect. Attractive individual carton.
Stock No. 250.....\$3.50 list



Fixed Condensers
Highly polished metal end plates with adjustable soldering lugs. Bakelite plates—mica insulation—brass electrodes—gives maximum results.
Used by leading set builders.
All popular sizes—from 30e to 85e list.



Audio Frequency Transformers
Highly efficient—popular price—fully shielded in an enameled metal case.
Stock No. 1500.....\$2.25 list
Stock No. 1550.....2.50 list



Variable High Resistance
Controls oscillation and regulates quality and volume. Highly mica plated metal shell with moulded Bakelite knob.
Range 0 to 200,000 Ohms
Stock No. 2120.....\$1.25 list
Range 0 to 500,000 Ohms
Stock No. 2150.....\$1.25 list



Interference and Static Eliminator
Moulded Bakelite case with insulated adjusting screw.
Stock No. 1800.....\$2.50 list



Variable Condensers
Moulded Bakelite case.
Balancing condenser .000003 to .00005 M. F.
Stock No. 1900.....\$1.00 list
Variable grid condenser .00015 to .0005 M. F.
Stock No. 1950.....\$1.00 list

Real Sensation of the Year
CHELSEA
TRUPHONIC SIX—\$60.00

Write us.
Chelsea Radio Co.
Chelsea, Mass.

LOG YOUR STATIONS
10c For a Copy of the Radio
Log Book. 16 Pages.
"RADIO," San Francisco

Gerald Best's New Single Dial Control Receiver

with many late improvements will be described in the next issue of "RADIO." A real set for the home.

Here Is What "RADIO" is Doing For Its Readers:—

A NEW SERVICE. An assurance of success to you in building your next radio set. A guarantee to help you make your present set work better. The publishers of "RADIO" have a matching, testing and calibration laboratory at your service to help you get the most out of your radio set. Gerald M. Best, Technical Editor of "RADIO," and D. B. McGown, formerly a radio inspector with the radio service,

are in charge of this laboratory. We have sufficient testing equipment on hand to serve the needs of the radio man and we are ready to match, test and calibrate your radio apparatus at unusually low rates. Furthermore, if your dealer cannot supply you with matched parts, we will purchase radio parts and apparatus for you—test, match and inspect each part—ship it to you and charge you only the regular selling price of the merchandise.

When you secure your parts from us there is no charge for testing and matching. Many of our readers live in small communities—in rural districts and, in many cases, miles from a reliable radio dealer. To these readers we can offer a real service. Let us secure the parts you want—anything at all—let us protect you and insure success in building your radio set. Tell us what you want. We will do the rest.

Accurate — Reliable — Prompt

SERVICE—PLUS! There are no delays. You can wire us a list of parts you want us to secure for you and we will give you prompt service. We can serve you—regardless of where you live. If you are located in

San Francisco, call in person at the laboratory and we will match your parts while you wait. This service is open to all. The matched and tested apparatus is certified by Gerald M. Best and D. B. McGown.

Schedule of Rates

These rates apply only in cases where apparatus is shipped to us. Apparatus purchased through our laboratory is tested and matched without extra cost.

FIXED CONDENSERS—

25c cents for measurement of capacity.

B BATTERY ELIMINATOR CONDENSERS—

Checking working voltage, both a.c. and d.c., any size up to 1000 volts.....\$1 per condenser

COMPLETE SETS—

Laboratory test of any complete set, up to 10 tubes. Complete check-up of all parts....\$5.00

B BATTERY ELIMINATORS—

Measurement of voltage output at specified current drain for each voltage tap. Checking of connections for wiring defects.....\$2.00

SPECIAL SERVICE—

Facilities are available for testing transmitters and transmitting equipment of all kinds. Phantom and real antennae are available for testing complete transmitters on all wavelengths up to 2500 meters. Power is available for testing apparatus and power supply equipment on any of the following circuits:

D.C. to 2000 volts.

A.C. testing at commercial frequencies and voltages up to and including 6600 volts, single or polyphase.

Testing equipment is also available for use with 500 cycle single phase to 5 K.W. High voltage D.C. from a mercury arc rectifier up to 10,000 volts is also available. Suitable meters of all types and kinds are on hand for testing such equipment and making all necessary measurements to make proper and complete tests of such equipment and apparatus.

Owing to the special nature of such tests, no regular fees will be quoted, but correspondence is invited on this subject.

MATCHING—

COILS—Any make. Matching inductance and matching resistance, 35c per coil or \$1 for a set of three. Thorola, Camfield, Benjamin, Precision, All American, Bremer-Tully, Quadraformer and other standard coils can be matched to operate perfectly with single, double or triple condensers. When condensers are to be matched with coils, the charge is 50c per unit, consisting of condenser bank and coil. In other words, a three gang condenser can be matched with three separate coils at a cost of \$1.50. Curves, per unit, \$1.00 additional per curve.

VARIABLE CONDENSERS—Air condensers, variable. Checking maximum and minimum capacity, 25c for a single condenser, 50c for a two gang condenser, 75c for a triple gang condenser. Curves, \$1 additional per bank.

TRANSFORMERS—AUDIO—

Any make. Matching pairs, testing for grounds, shorts and open circuits and matching with proper amplifier tubes, 50c each. Transformer curves of frequency characteristics from 35 to 8000 cycles, \$1.50. (Impedance or inductance measurements at any desired frequency.)

VACUUM TUBES—

Any standard type for receiving sets, 50c for measurement of amplification constant at any one audio frequency. Ten cents per tube for matching pairs. Complete sets of tubes matched for multi-tube sets. Proper oscillator, detector, r.f., amplifier and power tubes selected for various parts of the circuit. Ten cents per tube in lots of 4; 25c per tube in quantities of less than 4.

GRID LEAKS—

25 cents each for accurate measurements of d.c. resistance.

I. F. TRANSFORMERS—

\$2.50 for matching a set of intermediate frequency transformers with specified tuned transformer, \$1.00 for frequency characteristic curve. An extra charge is made if tuning condenser is furnished by us.

How to Order—

When ordering parts from us please be sure to give maker's name—type number and style. If you want a complete set of parts for a Hammarlund or Bremer-Tully receiver, for example, just tell us to send you a complete set of matched parts for such a receiver. Send money order, certified check or cash with order. You pay the express charges. Remember—there is no cost for testing and matching parts when secured through us.

How to Ship—

If you have parts on hand to be tested, matched or calibrated, ship them to us prepaid. Securely pack all shipments in wood boxes or heavy cartons. Insure your shipments. We will return the apparatus to you in the original carton. The shipping charges are to be paid for by yourself. Plainly mark all apparatus as follows:

“Laboratory”

PACIFIC RADIO PUB. CO.
435 PACIFIC BUILDING,
SAN FRANCISCO, CAL.

LEADING PUBLICATIONS



The CITIZENS RADIO CALL BOOK is Radio's Greatest Publication. Circulation 300,000. Contains all the latest information of construction so simply told anyone can build superheterodynes as easily as laboratory men. Large rotogravure section contains beautiful photos of leading station announcers and entertainers. Also contains the most complete list of the World's broadcasting stations—every one—their transmitting schedules, wavelengths, slogan and plenty of space under each to log that station for future reference. Really Radio's Greatest Publication. You'll be delighted.

Price only 50 cents postpaid

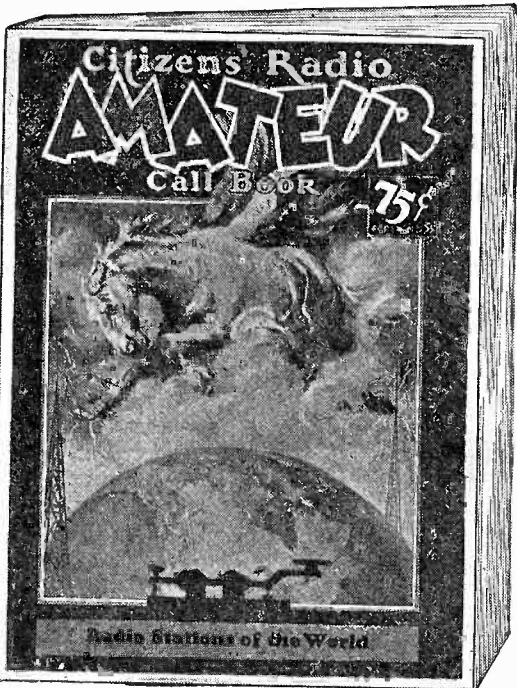

The CITIZENS RADIO AMATEUR CALL BOOK is an international list of call letters, names and addresses of the World's amateur transmitters—ARRL official traffic relay stations list. Compiled from official sources and the most authentic list obtainable anywhere. Remember, the whole World, U. S., Canada, Australia, France, Germany, etc. The whole international list. Also commercial ship and land stations.

Price only 75 cents postpaid

If you are unable to obtain either of the above mentioned publications from your news dealer or radio store, they will be sent postpaid upon receipt of the amount in U. S. stamps, coin check or P. O. money order.

Citizens' Radio Call Book

510 S. Dearborn St.

Chicago, Ill.

From the Radio Manufacturers

(Continued from page 40)

The Westinghouse Retrox Trickle Charger consists of a new copper oxide rectifier and a step-down transformer to give a 6 volt output from the 110 volt line. The rectifier consists of a series of metallic disks coated with copper oxides connected in parallel to give full wave

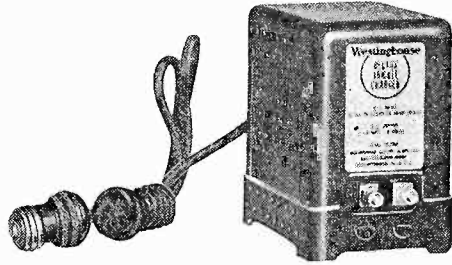

rectification. Each disk is a complete rectifier in itself, offering low resistance to the flow of current in one direction and very high resistance to flow in the other direction. This rectifying action does not depend upon any applied pressure. The Retrox is rated at 12 watts,

115 volts a.c. input and ½ ampere 6 volt d.c. output.

The Crosley Merola, "magnetic electric reproducer" is a new unit for converting a mechanical phonograph into an electrical machine when used with the audio amplifier and cone speaker of a

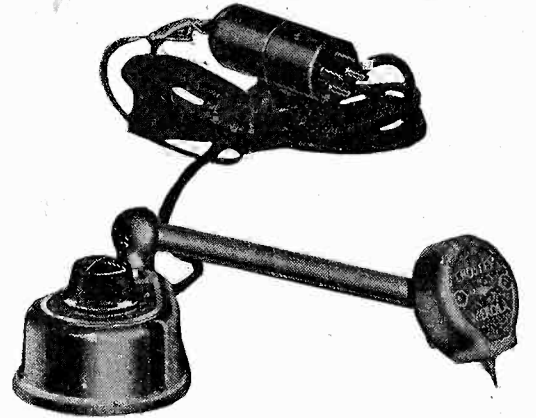

radio set. The unit replaces the usual tone-arm and its plug is inserted in the detector tube socket of the radio. Its armature coil is shunted by a rheostat which acts as a volume control.

BELIMINATOR \$22.95

COMPLETE WITH RAYTHEON TUBE

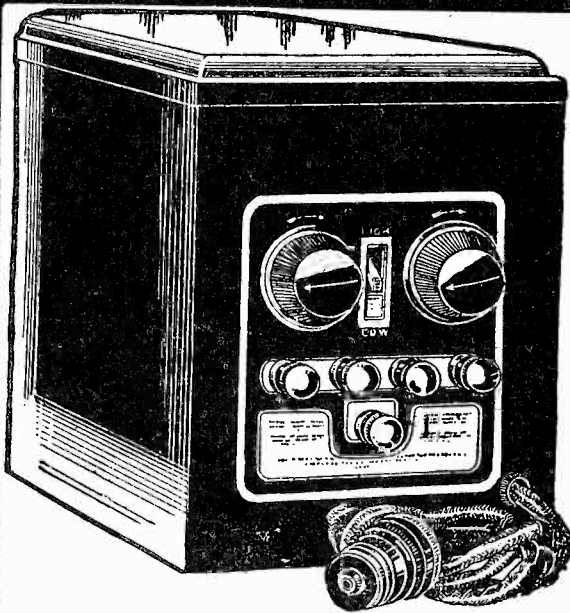

Capacity 50 Milliamps, 200 Volts
Adequate for 1 to 15 Tubes

Delivers Smooth, Steady "B" Current—No Hum

The materials used in making the Raytheon are the finest unit parts, laboratory matched; the case with its rich, genuine Brewster Green Duco finish; the metal fittings of polished nickel; the genuine RAYTHEON tube. Comes completely wired and ready to use from 60-cycle, 110-volt alternating current. The filtering system with its extra capacity, 1000-volt test condensers, and massive, oversize 40-Henry chokes smooth out every ripple and hum from the alternating current. There is nothing to deteriorate, wear out, or replace; Raytheon is good for a lifetime of service and fully guaranteed. Capacity, 50 milliamps up to 200 volts for 15-tube sets or less.

Send only \$3.00

Belmont Scientific Laboratories

1303 Wilson Ave., Dept. F
Chicago, Ill.

Positively the Greatest Value in "B" Eliminators

While the regular market price of Raytheon is around \$50.00, our factory-to-you price is only \$22.95. At this price, everyone can afford to own a Raytheon and forever discard his B batteries. A "B" eliminator enables you to draw your B current from the light socket. There is more uniform and constant power, no more battery replacements, more volume, improved tone quality, positive regulation of voltage, and absolutely NO HUM. By stopping battery replacement, Raytheon pays for itself.

Cannot Deteriorate With Use—Nothing to Wear Out!

Contains no materials or parts which are subject to wear. Always delivers the same, unvarying output of current. Employs the use of the famous Raytheon tube to rectify the current. There is no filament to burn out, sag, or wear, therefore lasts forever. Has full wave rectifications, exceptionally efficient. Uses but a few cents worth of current a week. No liquids or chemicals. This is a genuine high capacity eliminator and a quality product throughout.

Belmont Scientific Laboratories,
1303 Wilson Ave., Dept. R.
Chicago, Ill.

Enclosed find \$3.00. Ship "B" Eliminator complete with Raytheon tube. I agree to pay expressman \$19.95 plus slight express charges.

Name.....

Address.....

City..... State.....

Direct from the socket

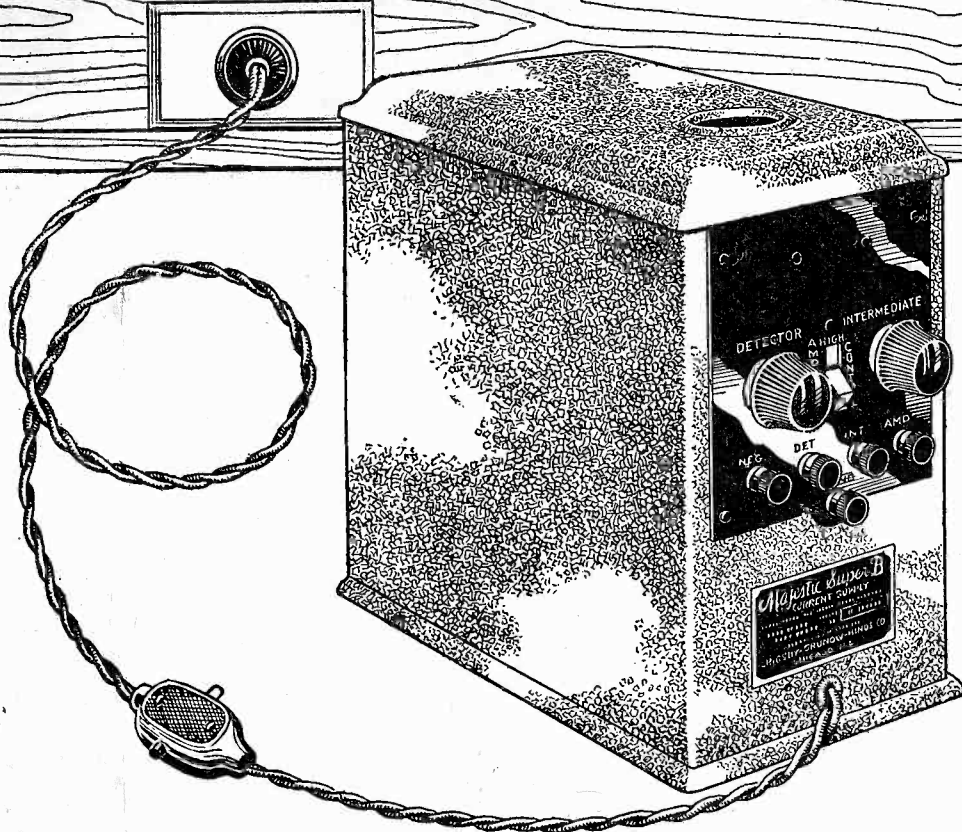

Majestic "B" Current Supply

delivers pure direct current—from your light socket

Majestic Standard-B

Capacity, nine 201-A tubes or equivalent. 45 milliamperes at 135 volts.

\$29.00

Raytheon Tube \$6.00 extra

Majestic Super-B

Capacity one to twelve tubes, including the use of power tubes. 45 mils. **\$31.50**
(AS ILLUSTRATED)

Raytheon Tube \$6.00 extra

Majestic Master-B

Positive control of all output voltage taps. For sets having high current draw or heavy biasing batteries. 60 mils. at 150 volts.

\$34.00

Raytheon Tube \$6.00 extra

5 Points of Superiority

1 Better Reception

No hum. Superior to any source of power.

3 Dependability

Maximum, unvarying power always available.

2 Economy

Low first cost. Cheapest and best form of "B" Power. Costs only a fraction of a cent per hour.

4 Durability

No acid or liquids. Uses Raytheon Tube; no Filament to burn out.

5 Flexibility

Voltage can be accurately adjusted to meet varying conditions in every city—and on any set.

Ask for a demonstration on YOUR SET

(Can be purchased on deferred payment plan)

GRIGSBY-GRUNOW-HINDS-CO. 4580 ARMITAGE AVE. CHICAGO, ILL.

W. J. SEROY, Pacific Coast Sales Manager
4069 Hollis Street, Emeryville, (Oakland), Calif.

SEND COUPON BELOW
FOR FREE BOOKLET

SAVE \$45⁰⁰



R. L. Duncan,
Director, R.I.A.

I am cutting the price
of our radio course
to the bone because I
need 450 more stu-
dents this month to
fill the big demand
for trained radio men.

AS fast as we can supply graduates the shipping companies are snapping them up as radio operators to travel to the far corners of the earth. Other branches of radio are insistently clamoring for more trained men to fill responsible, well-paying positions on shore. So I am making this drastic reduction in the cost of our Home Study Course to radio amateurs only to induce more young men to make radio their life career.

**Pass U.S. Government
Radio License Examination**

This course eliminates the elementary phases of radio with which most amateurs are familiar. It carries you right through the more advanced radio operating technique and teaches commercial procedure thoroughly. It qualifies you to pass your U.S. Government First Class Commercial License Examination.

Study at Home—Send Coupon

Moreover you can study at home—without giving up your present occupation. Radio Institute of America is the world's oldest radio school. The instruction is the finest obtainable anywhere. To be sure of getting the benefit of this special course send for booklet A-2. Just fill in the coupon below. It costs you nothing to receive this 40-page booklet, chock-full of information.

**RADIO INSTITUTE
OF AMERICA**

Formerly Marconi Institute
Established in 1909

322 Broadway New York City

CUT HERE

Radio Institute of America
322 Broadway, New York City

Please send me your special booklet A-2 with full information about the reduced price of your radio course for amateurs.

Name.....

Address.....

Make Your Own
Three-Foot Cone Speaker
in Less Than an Hour

WORLD'S FINEST LOUD SPEAKER
~ GENUINE ~
"ENSCO" 3" CONE KIT

ONLY \$10
Can be Assembled
in Less Than an
HOUR

ONLY \$10
The Original Three Foot
Cone Speaker
KIT

NO DISTORTION
THE SOLUTION OF THE
LOUD-SPEAKER PROBLEM
The Advice of Leading Engineers

PERFECT
FIDELITY

Complete parts furnished in kit form. We guarantee this speaker the equal of any manufactured cone speaker at any price. With this **THREE FOOT CONE SPEAKER** you hear all the tones. It brings out the true depth and beauty of orchestral and instrumental music. Can be operated softly for Living Room Music or full volume for dancing, and without trace of distortion. Kit includes famous "ENSCO" cone unit, the only direct-drive, distortionless unit for large cones; Alhambra Fonotex for big cone, with brass apex, two Sepia Prints showing cabinet or simple stand construction. All necessary instructions. Buy this wonderful speaker under our absolute guarantee. Your money back if you are not convinced that it is the finest reproducing medium obtainable at any price. It works on any Set, with ordinary Tubes or with Power Output.

Engineers' Service Company
25 Church St. (Desk Y)
New York City

Send No Money!

Write your name plainly, as indicated below, then mail and complete kit will be forwarded to you. Just pay postman \$10.00 upon delivery.

Engineers' Service Company
25 Church St. (Desk Y)
New York City

Hoyt
**B-ELIMINATOR
VOLTMETER**

This new instrument with the necessary high resistance of 1000 ohms per volt gives true voltage readings of the output of B-Eliminators. Proper operation of Radio Sets by B-Eliminators demands accurate knowledge of voltage settings. Dealers and Service-men can get them accurately with the HOYT B-Eliminator Voltmeter.

Price 0-300 volt range, \$30.00. Higher ranges at higher prices.

BURTON - ROGERS COMPANY
Sales Dept. for HOYT Electrical
Instrument Works, Boston, Mass.

Let Us Show You How to Get a Complete

4, 5 or 6 TUBE KIT FREE

SIMPLICITY KIT, \$52.50

Send Postal For Particulars

B. C. L. RADIO SERVICE CO., Inc.
221-R Fulton St., N. Y. City

INFRADYNE TIPS

(Continued from page 12)

lead to a 22½ volt supply. The filament current rheostat may be turned all the way on at all times if this scheme is used.

Each grid and plate lead in the set should be kept at least ½ in. from anything else. Do not cover them with spaghetti and run them along the base-board among the filament leads in an attempt to improve the appearance of the wiring.

The infradyne can be logged definitely and conveniently, especially if National type B dials are used. Instead of writing call letters on the space available, write the wavelength, putting the figures vertically one below the other. The tuned r.f. dial spreads out those below 300 meters while the oscillator dial spreads out those above. The set should be properly adjusted before starting to log, marking the position of the four indicator ends on infradyne amplifier and putting a scratch on the plate of the fixed trimmer to show its setting.

If the plate supply for the 99 tubes is corrected to the 45 instead of the 90 volt post, as previously described, there should be little difficulty in satisfactorily operating the infradyne from a good B battery eliminator such as the Majestic Master B, the All-American Constant B, the General Radio, and probably others which the writer has not tested. The main requirement is that the eliminator delivers 67½ volts to the 45 volt post, supplying plate current for the 199 tubes, 90 volts for the A tubes and 135 volts or more for the power tube, as shown by a high resistance voltmeter.

Any eliminator can be combined with two 45 volt B batteries, the batteries being used to supply 90 volts to the two tuned r.f. tubes and the first audio, the eliminator supplying the balance. This elimination avoids any possible voltage reaction through the eliminator onto the rest of the set when the series plate resistance on the infradyne unit is changed.

When testing for trouble, always use B batteries throughout. The high d.c. resistance of an eliminator may indicate a fault that does not exist in the set and thus give misleading results.

EXPERIMENTAL SHOP

(Continued from page 26)

working glue can be made by mixing with an egg-beater 18 ounces of casein glue with 1 ounce of cold water. It will be ready to use after it has stood for half an hour when it will have the consistency of very ripe Camembert cheese. It may be applied with a spatula or brush, which should be well washed afterwards as the glue is almost waterproof when dry and dries quickly. Ammonia will soften it. The glued wood can be worked upon six hours after the joint is made.

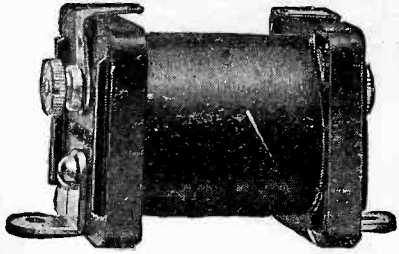

R. F. CHOKE

For Majestic Music Samson Chokes must be used

"All sense of listening ceases—you are in the great artist's presence."

say the musically critical who have simply added

Samson Chokes

to their radio receiving sets to eliminate howling, "motorboating" and other disturbing noises—for at all times these chokes keep radio and audio frequency currents where they belong.

For this purpose Samson Chokes cannot be approached because their patented helical winding prevents the choke acting as a by-pass condenser at certain frequencies and reduces distributed capacitance effect to a negligible minimum. These chokes have no pronounced self resonant points. Special bulletins on the uses of these chokes are available.

No. 85 Samson R.F. Choke (85 millihenries)	\$2.00
No. 125 Samson R.F. Choke (250 millihenries)	\$2.25
No. 500 Samson R.F. Choke (500 millihenries)	\$2.75
No. 3 Samson A.F. Choke (3½ henrys)	\$3.25

Our book—"Audio Amplification"—already accepted as a manual of audio design by many radio engineers—contains much original information of greatest practical value to those interested in bettering the quality of their reproduction. Sent upon receipt of 25c.

SAMSON ELECTRIC COMPANY



MAIN OFFICE: *Manufacturers*
CANTON, MASS. *Since 1882*
Factories at Canton and Water-
town, Mass.

DISTANCE WITHOUT DISTORTION

Sensitive? You bet!

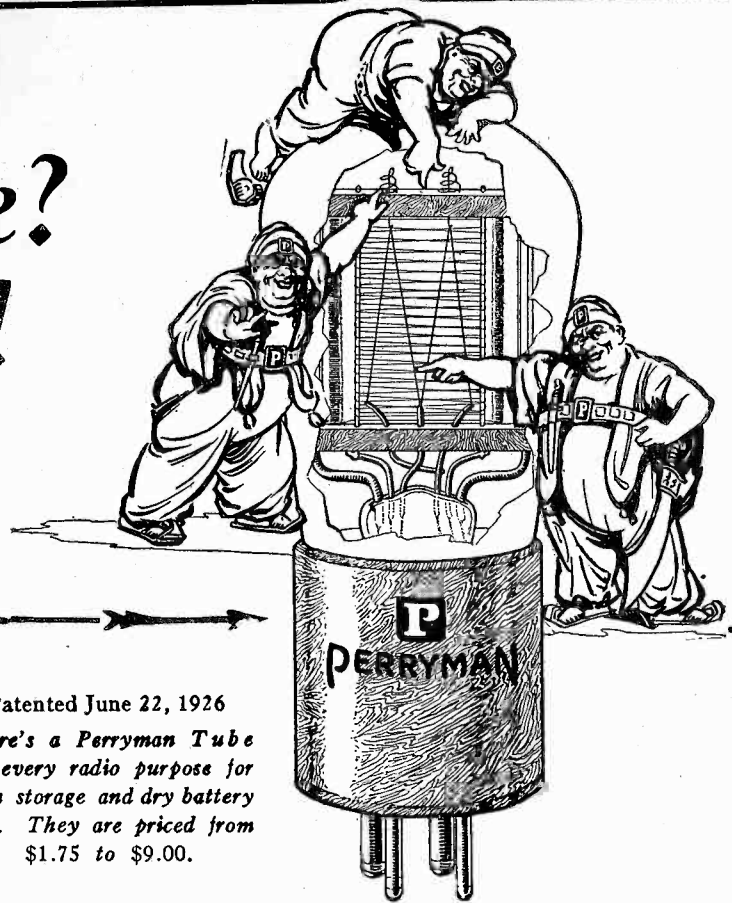

Patented June 22, 1926

There's a Perryman Tube for every radio purpose for both storage and dry battery sets. They are priced from \$1.75 to \$9.00.

Remember the story of the little girl who was suspected of being a Princess? To make certain they placed a bean under the mattress in her bed and sure enough she was so uncomfortable she couldn't sleep. That's pretty sensitive—but it's a long way from equalling the sensitivity of P.D. 200-A, the Perryman Super-Sensitive Detector. This tube penetrates a mattress of air thousands of miles wide and delivers the station you want—and only that station.

P.D. 200-A makes local stations out of distant stations and brings in all stations clearly and distinctly with minimum tuning.

Hear Perryman Tubes in operation at your dealer's and judge their performance for yourself. That's the only test that counts.

PERRYMAN ELECTRIC CO., INC., 33 W. 60th Street, New York, N. Y.

Pacific Coast Representative:
Atlantic Pacific Agencies Corp.
383 Brannan Street, San Francisco

PERRYMAN

RADIO P TUBES

"DISTANCE WITHOUT DISTORTION"

Coming—Next Month

A NEW single dial control receiver by Gerald M. Best. This receiver incorporates a number of latest radio refinements including the shielded Quadraformers, new illuminated drum dial and window panel, new gang condenser, new Phasatrol system of balancing the r.f. amplifier and several up-to-date improvements by Best himself. The new set uses five tubes. Don't miss this feature in the next issue of "RADIO." A subscription for one year at \$2.50 insures receipt of copy.

"RADIO" for APRIL

Bradleystat

PERFECT FILAMENT CONTROL

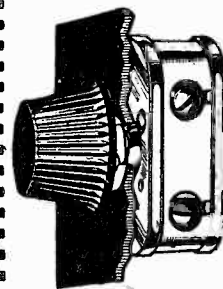

Provides complete noiseless filament control for all radio tubes without change of connections. Metal parts are nickel plated. One hole mounting. Self contained switch opens battery circuit when desired.

Allen-Bradley Co.

Electric Controlling Apparatus
279 Greenfield Avenue Milwaukee, Wis.

Tell them that you saw it in RADIO

AERIAL WIRE

ENAMELED
TINNED COPPER
BARE COPPER
SOLID
STRANDED
BRAIDED

COILS

MAGNET WINDINGS
FOR LOUD SPEAKERS
TRANSFORMER AND
CHOKE WINDINGS
FOR BATTERY
CHARGERS
AND ELIMINATORS
COILS FOR AUDIO
TRANSFORMERS

MAGNET WIRE

ENAMELED
COTTON COVERED
SILK COVERED
SINGLE OR DOUBLE
WHITE OR COLORED

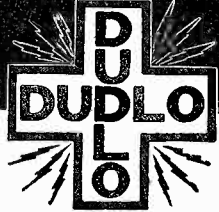

Dudlo Manufacturing Corporation

FORT WAYNE, IND.

A. S. LINDSTROM CO.—Western Representative

274 Brannan Street
San Francisco

324 N. San Pedro Street
Los Angeles

95 Connecticut Street
Seattle

146½ N. 10th Street
Portland

221 South West Temple
Salt Lake City

RADIO ADS

A Classified Advertising Section Read by Better Buyers

8 cents per word, net. Remittance must accompany all advertisements.
Include name and address when counting words.

Ads for April Issue must reach us by March 3rd

RADIO SCHOOL—Extension courses in practical radio offered for the radio repair man and the enthusiast. **McKAY INSTRUMENT CO.**, 424r Morgan Bldg., Portland, Ore.

SEAGOING OPERATORS—Blueprint of two kilowatt spark converted to ICW and commercial radio traffic manual—only book of its kind in world. Both for one dollar. **Howard S. Pyle**, 1922 Transportation Building, Chicago. (TC)

DO YOU GET TIRED of buying "B" batteries? A lifetime Edison will solve your troubles. Good, live, large size elements connected with pure nickel wire, electrically welded, 7c pair. All parts for sale. Sample cell and dope sheet, 10c. **Paul Mills**, Woodburn, Oregon.

MAKE \$100 weekly in spare time. Sell what the public wants—long distance radio receiving sets. Two sales weekly pays \$100 profit. No big investment, no canvassing. **Sharpe of Colorado** made \$955 in one month. Representatives wanted at once. This plan is sweeping the country—write today before your county is gone. **OZARKA, Inc.**, 431 N. LaSalle Ave. B, Chicago.

A-1 CRYSTAL; guaranteed best crystal obtainable. Postpaid fifty cents each. **Harry Grant, Jr.**, 904 Oak Grove Ave., Burlingame, Calif.

FOR SALE—Superheterodyne experimenter has accumulated many used parts which are in perfect electrical condition and for all purposes as good as new. Super Transformers: Victoreen, \$20; Remler matched 2 air 2 iron with condensers, \$15; Sampson (Cotton), \$10; Baldwin-Pacific, \$6; 4 Silver-Marshall shielded matched, \$12; Infradyne Condensers, \$2.50; General Radio 2-1 Audio, \$4; Dubilier 902-4mfd. Condensers, \$2.50; many others. Postage paid. **J. W. HOWLETT**, Santa Paula, Cal.

HOW IS YOUR RADIO SET WORKING? Send us your set parcel post prepaid and we will test it FREE. We furnish you a written report describing felt faults found and the cost of remedying them. Your set is held until you pass on our report. **McKAY INSTRUMENT CO.**, 424r Morgan Building, Portland, Ore.

FOR SALE—Ultra Audion Set, \$9.50; Reinartz, \$13.50. **DOMBROWSKI**, 4341 So. Campbell Ave., Chicago, Ill.

FOR QUICK SALE—1 Remler Infradyne Amplifier, \$21.50; One each Remler Twin Rotor Variable Condenser, .00035, .0005 and .0001 at \$4.00 each. Set of three Thorola Doughnut Coils, \$5.25. Thorola Cone Speaker, \$17.00; Dictogrand De Luxe Speaker, \$21.50; Dictogrand Standard, \$14. I paid \$18 for this speaker. Send cash or money order to **H. D. FRAZEE**, 130 Fifth Avenue, San Francisco, Cal.

TRADE—0 to 5 Hotwire Meter for smaller. **MARTYN**, 475 13th St., San Francisco, Cal.

FREE—Selective Crystal Set Hook-up. Enclose two cent postage stamp with request to **California Radio Minerals**, 904 Oak Grove Avenue, Burlingame, Calif.

FOR SALE—Last 20 issues of "RADIO" from August, 1925, to March, 1927, inclusive; perfect A-1 condition. Price \$5 net. Also following 1923 issues, slightly spoiled: Jan., Feb., March, Apr., May, June, July, Sept., \$1.50 net. **R. M. HARRIS**, Star Rt., Box 5A, Grimes, Calif.

BREMER-TULLY Counterphase 6; Factory built. Bargain price for cash. Write Desk B-T, 904 Oak Grove Ave., Burlingame, Calif.

FREE quotations given on tested, matched and calibrated radio parts in the new wonderfully equipped laboratory of the **Pacific Radio Publishing Co.**, publishers of "RADIO." Let us insure good results from your set. Tell us what you want. We will get anything for you at regular list price and test, match and inspect all apparatus without cost if purchased through our laboratory. "RADIO," Pacific Bldg., San Francisco, Calif.

SHORT AND LONG WAVE RECEIVERS Calibrated in WAVELENGTHS. **Gerald M. Best** and **D. B. McGown** will do this for you in the new laboratory of "RADIO" magazine. Ship your set to us and we will log the dials in wavelengths. The price for this work is only \$2.50 for a complete calibration. "RADIO," Pacific Bldg., San Francisco, Calif.

VIBROPLEX and **Albright** semi-automatic transmitters. Will sell used machines in good condition that have been taken in from railroad and telegraph companies for \$9.00 each postpaid in United States. Send remittance with order. **K. N. Ford**, 1411½ Alta Vista Blvd., Hollywood, Calif.

WHO'S WHO AND WHERE

(Continued from page 37)

We received a very neat Christmas card from **WMW**. Why don't some of the rest of you stations rig up some greeting cards?

Bill Chadwick, SS. Yorba Linda, is now running between Sabine, Texas, and New York, after making a trip to Toulon, France. He gets his TR into **KFS** every night, which is pretty good shooting.

Lyman Packard is just returning from an interesting trip to Bombay on the *SS. Lio*. dope about the East Coast gang in this column. Because it's too far to walk to get it.

You can buy stamps from any drug store.

While young **George Young**, now famous, was splashing his way from Catalina to the United States, much activity was going on in the ether above him. **Fred L. Dewey**, District Manager of the **F. T. Co.**, kept **Windsor of KOK** on the hop for seventeen hours, copying A.P. stuff on short waves, while "Wally" **Walling**, Service Manager at **KSE**, boarded the *SS. Avalon*, and with Operator **Semrau** on the tug *Patrick*, kept the air blue on 706 meters. Operators **Everest**, **Bradley** and **Morenus** wore out a couple of typewriter ribbons at **KSE**, running up a total of 9980 words in the seventeen hours of excitement. The two companies showed a mighty good spirit in their dividing up of the traffic, each successfully handling its business without the least trace of friction. They both deserve much credit.

The operator on the *SS. West Camargo*, whose name we didn't get, worse luck, put over a mighty clever piece of work on his last trip from South America. While coming through the Straits of Magellan his motor-generator broke down, leaving him with no other power supply than the ship's D.C. Not to be daunted by that unlucky occurrence, he rigged a brass wheel onto the motor shaft and used it as a chopper in series with the transformer primary. With this I.C.W. transformer supply he worked about 1000 miles at night and 400 miles in the daytime. If anyone knows this operator's name we should appreciate it if you would send it to us. Such ingenuity deserves special recognition.

The whole fishing fleet out of Boston is now boasting R.C.A. tube transmitters, radio compasses, three tube receivers with loud speakers. This fleet is comprised of about thirty trawlers, and the operators' pay, which increases with the length of service, is as high as \$130 a month. The boys are expected to handle the radio service and nothing else. Let's go fishing.

Dick Clark writes from Icy Bay, Alaska, that when the mosquitoes get out of the way he has a great time looking out of the shack and seeing the ocean splash several miles away. **Dick** has been amusing himself by combining Ham principles and commercial antiques. He has been getting 200 miles per watt out of one "A" tube on 600 meters, having worked a distance of 800 miles altogether, using the **Delco** system for his plate supply. How's that?

Press Skeds of GBR (Rugby, England) (GMT)

LLOYD V. BRODERSON

SS. President Monroe (KDAR)

18,740 meters 01:48, 0800, 12:20, 12:00, 20:00, 24:00

Press Skeds of POZ (Nauen, Germany) (GMT)

13,000 meters 08:00, 11:20, 22:00 18:00

India Wx Skeds (GMT)

VPB Colombo, Ceylon 2300 meters 06:00, 18:00

VWB Bombay 2000 meters 07:00, 17:00

VWM Madras 1000 meters 09:00, 17:00

VWC Calcutta 2000 meters 08:30, 16:30

VWK Karachi 2000 meters 08:30, 16:30

BZE Matara, Ceylon 2000 meters 01:45, 13:45

Arabian Sea Wx (GMT)

BZE Aden 2000 meters 01:30, 13:30

Time Skeds (GMT)

POZ Nauen, Germany 13000 meters 12:00, 24:00

VPB Colombo, Ceylon 2300 meters 05:57, 17:57

VWC Calcutta, India 2000 meters 08:25, 16:25

FRESHMAN AUTOMATIC CHARGER

Connects
Right to
Your
Light
Socket

\$15

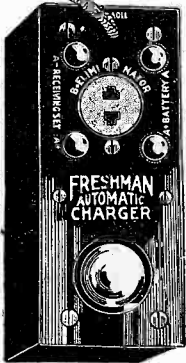

NO
MORE

"A" BATTERY
TROUBLES

Sold by Authorized Freshman
Dealers Only

Write for new literature

CHAS. FRESHMAN CO., INC.
Freshman Bldg., New York

Send For This QUOTATION NOW!

Let us mail you, free of cost, a copy of the rate schedule for testing, matching and calibrating radio apparatus. Our new Matching and Testing Laboratory is now ready for you. Gerald Best and D. B. McGown will match and test your radio parts. The rate schedule is yours for the asking. Use the coupon.

RADIO, Pacific Building,
San Francisco, Calif.

Send me your rates for testing
and matching apparatus.

Name.....

Address.....

USE THESE FROST-RADIO PARTS IN YOUR NEW INFRADYNE

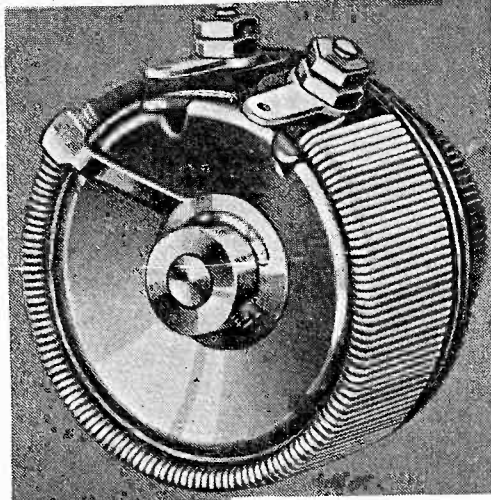

FROST-RADIO Rheostats

Type 700 Metal Frame.....50c
Type 800 Bakelite.....75c

Write for Complete INFRADYNE Literature. Address—

HERBERT H. FROST, Inc.
160 NO. LA SALLE STREET, CHICAGO
NEW YORK LOS ANGELES

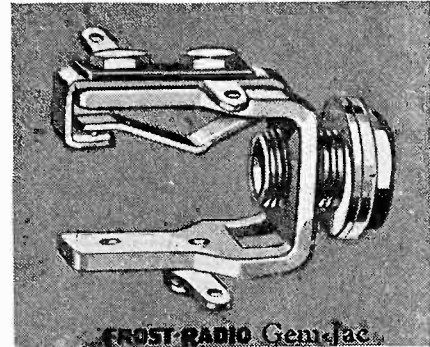

Price
40c



FROST-RADIO No. 530 Bakelite Socket. Price 40c

famous "Perfect" ONLY ELIMINATOR 4.75

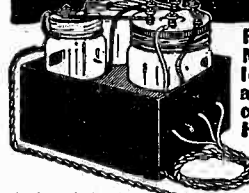

FOR ANY SET
Makes "B" Batteries obsolete. Costs much less than a set of cells. Ends plate current troubles forever. Hook it up just as your old batteries were connected. No "frying" noises caused by old cells. Sharper tuning — more power because of steady flow of current through tubes.

No Extras
to Buy

Completely equipped and assembled. Our amazingly low price of \$4.75 covers everything. Just plug in on any light circuit, direct or alternating. Gives power up to 90 volts, using full wave of power supply. Operates any set up to 7 tubes. Thousands of enthusiastic users in all parts of the country.

10 DAYS TRIAL

Money Back If Not Delighted

Just send \$1.00 now. Pay postman balance of \$3.75 (plus few cents postage) when he delivers your Eliminator. Use it 10 days. If not delighted, return in good condition and we will refund your money. Our guarantee protects you absolutely. Reference—Pearl Market Bank, Cincinnati, Ohio.

PERFECT ELIMINATOR CO.

U National Theatre Bldg., Cincinnati, Ohio

Tubes Matched for Ten

Send us your vacuum tubes. Let us select the best detector, oscillator, r.f. or audio amplifier and see how much better your set will work. Price only ten cents per tube. Each tube will be plainly marked. We also sell selected tubes at regular retail prices.

Laboratory of "Radio," 435 Pacific Bldg., San Francisco

Gerald Best's Superheterodyne Blue Prints in half size. Sent postpaid for One Dollar.

"RADIO"—PACIFIC BUILDING, SAN FRANCISCO

GET DISTANCE

\$1

AMAZING INVENTION FOR ANY RADIO

Why confine your radio programs to a few local stations when the expensive concerts, dance music and lectures of hundreds of big cities are ready for you? Connect this *distance getter* to your radio, tune according to instructions and presto—note the distant programs roll in! **SATISFACTION GUARANTEED.** Your money instantly refunded if you are not satisfied. The article on proper tuning, furnished FREE with each Distance Getter, alone is worth the price. Galloway of Chicago writes: "Results beyond all expectations. Cuts through locals like a knife." Homes of Palos, Ill., says: "Send three more for my friends. I get Denver and California easily."

MAIL COUPON TODAY!

Hazleton Laboratories
4554 Malden St., Dept. R, Chicago, Ill.

Send me Distance Getter, postpaid. Enclosed find \$1.00 (money order, stamps or check). Send C. O. D. plus small postage added.

Name.....

Address.....

City..... State.....

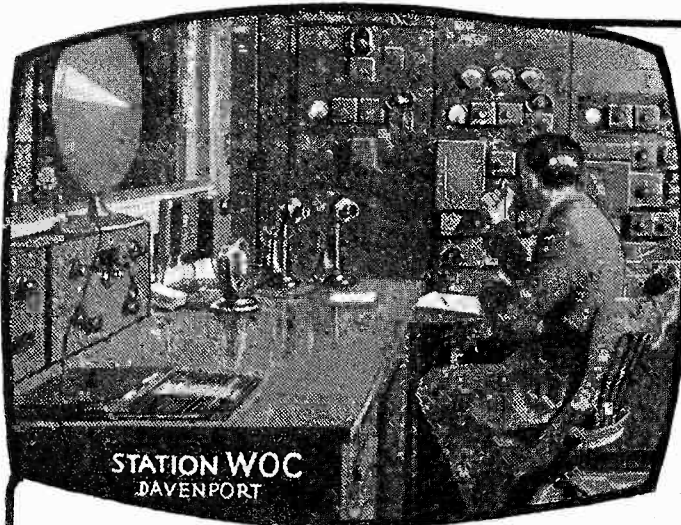

HERE'S WORK THAT IS ALMOST ROMANCE!

Now Owns a Radio Store
 "The Radio business is rushing just now. Building many Super Heterodynes, also doing installation and repairing. To your course I owe all my success in the Radio profession." A. J. Ommott, Bowman, N. Dak.

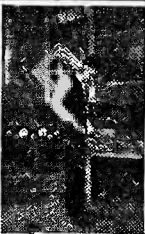

Controls First Car by Radio
 "I operate the portable broadcasting station in rear car, driving front car by Radio control. Will operate this car from New York to Frisco—13 months trip. Then we take the car around the world—a three years' tour. I owe it all to you." Leo Paul, New York City.

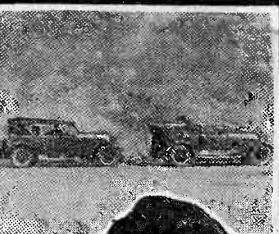

You Can Do What These Men Did!

I Will Train You at Home to Fill a Big Pay Radio Job

Get into the great new Big-pay Industry—Radio. If you're earning a penny less than \$50 a week, clip coupon now. Send for AMAZING FREE BOOK, "Rich Rewards in Radio." Why go along at \$25 or \$35 or \$45 a week when many are now earning \$50 to \$250 in the same six days as a Radio Expert? Hundreds of N. R. I. trained men are doing it—why can't you? I'll train you just as I trained them—just as I trained the men whose letters you see on this page. I'll teach you quickly at home in your spare time to be an expert in Radio, the Easy, Fascinating Big Money field.



Read the true stories printed in this border-of men who got out of the rut



Chief Engineer Station WEMC
 "Please communicate with my two junior operators here who want to increase their knowledge of Radio. Being a graduate of your course I know they could do nothing better for themselves than study it for it is the way to success in this profession." John E. Fetzter, Chief Engineer, Station WEMC, Berrien Springs, Michigan.
 Photo shows Graduate E. R. Spadoni in his own Radio store at Chicago, Ill. "Your course gets the credit," says Spadoni.

Big Jobs Go to the Trained Expert

It's the thoroughly trained man who gets the big jobs of this profession—paying \$75, \$100, \$200 a week and up. Free book gives all the facts. Hundreds of N. R. I. men are to-day holding down good, big jobs in the Radio field. Men like you—men like those whose stories I show you here. You can prepare just as they did by new practical methods, learn right at home in your spare time. Lack of experience no drawback—common schooling all you need. Our tested clear methods make it easy for you. Our years of experience in the big field of Radio means that we can train you as we have done thousands of others.

Clip Coupon Now for FREE BOOK

Most amazing book on Radio ever written—full of facts and pictures—tells all about the great Radio field, how we prepare you and help you start. You can do what others have done—GET THIS BOOK. Send coupon today—no obligation.

J. E. Smith, Pres.
 NATIONAL RADIO INSTITUTE
 Dept. CB-5
 Washington, D. C.

These Instruments Given FREE of Extra Cost

All instruments shown here and others sent to all my students free of extra cost under special offer. Clip coupon now—find out all about this big unequalled offer while you still have time to take advantage of it. This training is intensely practical—these instruments help you do the practical work.

My Radio Training is the "Famous Course That Pays for Itself"

● Make more money quick when you take up this practical course.

I show you how to increase your earnings almost from the start of your course through practical pointers I give you.

Howard B. Luce of Friedens, Pa., made \$320 in 7 weeks during his spare time. D. H. Suitt of Newport, Ark., writes "While taking the course I earned in spare time work approximately \$900." Earl Wright of Omaha reports making \$400 in a short time while taking his course—working at Radio in his spare time only! Sylvester Senso, 207 Elm St., Kaukana, Wis., made \$500. These records not unusual—these men are a few of hundreds.

And when you graduate, my big Free Employment Department helps you get the job. You get just the same preparation and assistance toward success we gave C. C. Gielow, Chief Operator of the Great Lakes Radio Telegraph Co., E. W. Novy, Chief Operator of Station WRNY, Erle Chambers, Radio Engineer for Stewart-Warner, J. E. Fetzter, Chief Engineer of Station WEMC. The National Radio Institute, established 1914, today offers you the same opportunity these men had under a contract that pledges you full satisfaction or money refunded on completing our training. It's your big chance to get into the great Radio field—Mail coupon TO-DAY for my big Free Book and proof

\$70 in one Day for T. M. Wilcox

"I am in business for myself and recently made \$70 in one day. I was an electrician of rich experience and was occupying a splendid position as telephone superintendent when I enrolled with your course believing it would open up greater opportunities—have not been disappointed. Estimate that Radio will be worth tens of thousands of dollars to me in the next few years." T. M. Wilcox, Belle Island, Newfoundland.

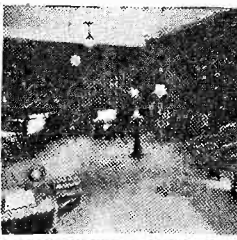

Kimball With WMAQ Chicago

"Accepted a position with the Chicago Daily News Station WMAQ. My income practically doubled, thanks to your fine course. I handle all consultation also do operating." Keith Kimball, Station WMAQ, Chicago, Ill.

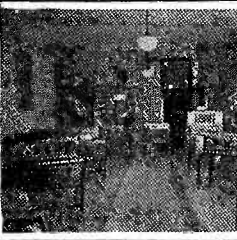

Promoted to Big Job

"Just been made Sales Manager of this Radio firm—received a very good increase in pay. Up to present have been getting salary which in 3 months enabled me to purchase a new car." R. Jones Bay City Mich.



MAIL THIS NOW!

J. E. Smith, President
 NATIONAL RADIO INSTITUTE
 Dept. CB-5, Washington, D. C.

Dear Mr. Smith: Without obligating me in anyway, send me your free book "Rich Rewards in Radio" and all information about your practical, home-study Radio course.

Name..... Age.....

Street Address.....

Town..... State.....

Originators of Radio Home Study Training

SEND THIS COUPON

FEATURING THE NEW GENERAL RADIO IMPEDANCE COUPLER

A NEW Amplifier Unit

which provides FAITHFUL reproduction of
FULL ORCHESTRATION

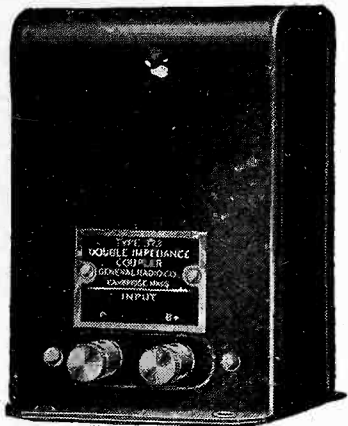

Type 373
Double
Impedance
Coupler
Price \$6.50
(2 required)



Type 285-D
Audio
Transformer
Price \$6.00
(1 required)



Type 387-A
Speaker
Filter
Price \$6.00
(1 required)

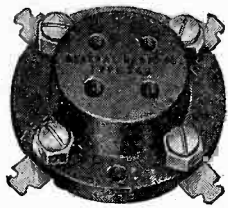

Type 349
UX-Tube
Socket
Price 50c.
(3 required)

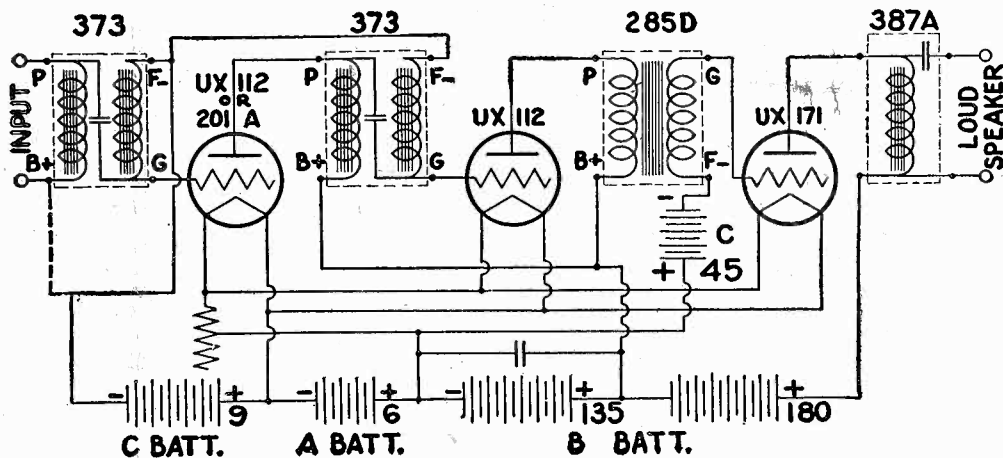

Type 410
Rheostat
6 Ohms
Price \$1.25
(1 required)

A graphic representation of vocal and instrumental tones as amplified by the Type 373 Double Impedance Coupler

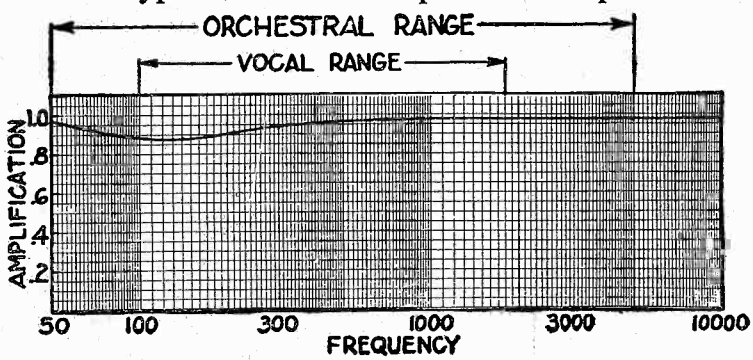

The extent in its range of even amplification is from appreciably below 60 cycles to over 10,000 cycles, with a gradual downward deviation of slightly less than 7% between 100 and 400 cycles. This deviation in an otherwise perfect amplification curve is so slight as to be practically negligible, because the ear of the average individual cannot detect a variation of intensity of much less than 25%.

The amplification curve, in fact, compares favorably with that generally obtained with resistance coupled systems which have the disadvantage of large sacrifices of plate voltages.

The above circuit diagram shows a combination of two stages of double impedance coupling and one stage of transformer coupling with speaker filter.

While the use of double impedances is not new in principle, the General Radio Type 373 Double Impedance Coupler is unique in design and performance. To facilitate installation, the complete unit, consisting of two impedances and a fixed condenser, is contained within a metal shell. It is connected in an audio amplifier circuit in precisely the same manner as a transformer. The amplifier combination shown above may be readily adapted to any standard manufactured or home constructed receiver, and will produce a very noticeable improvement in tone quality.

Its high and even amplification extends over the range of FULL ORCHESTRATION. The deep bass tones of the tuba are brought out in full timbre as are the shrill notes of the piccolo. The range of the human voice is covered with pleasing clarity.

The above amplifier combination has the further advantages that it may be used with the General Radio Type 405 Raytheon Plate Supply Unit. By substituting two Type 373 Units for the transformers of a two-stage transformer coupled amplifier the above combination may be completed and proper plate voltages provided by using the General Radio Type 400 Power Amplifier and Plate Supply.

Ask your dealer or write for Folder 373-R

GENERAL RADIO COMPANY, Cambridge, Mass.

GENERAL RADIO

Parts and Accessories

The General Radio Company has endeavored to make it possible for the experimenter to obtain its products with minimum of effort. A careful selection of distributors and dealers has been made. They are best suited to serve you. If, however, you are unable to obtain our products in your particular locality, they will be delivered to you, post paid, direct from the factory upon receipt of list price.

BROWNING-DRAKE RADIO

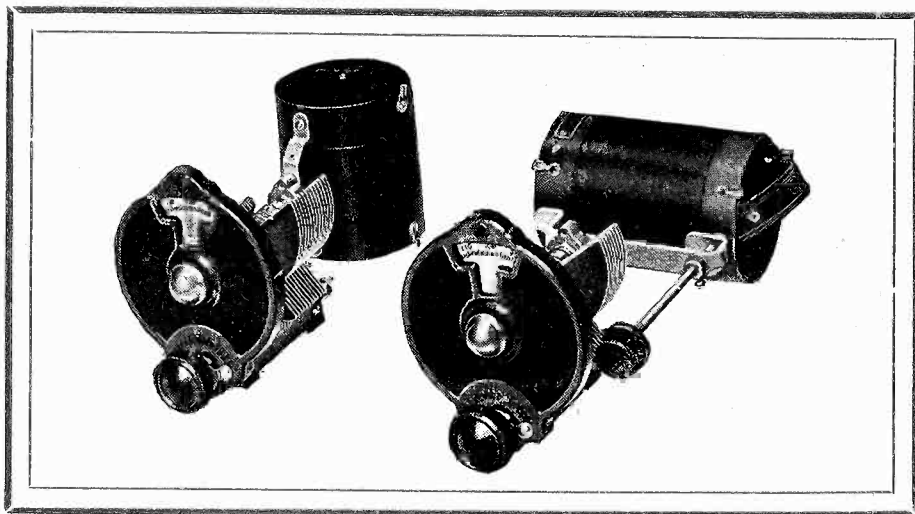

RECEIVERS—KITS—CABINETS

BROWNING-DRAKE evokes today the same genuine enthusiasm among radio fans as it did in the months following its introduction three years ago. The famous "slot-wound" primary has become known in the far corners of the earth, and many designs have been produced which bear so close a similarity to the genuine Browning-Drake as to confirm its scientific prestige by flattering imitation.

Browning-Drake kits — the product of this company — are

now available, conveniently packed in one box with instructions. Foundation units are now on the market for the first time, and the complete parts for the new Official Browning-Drake may be secured from almost any reliable dealer.

A complete radio service, including receivers, kits, and cabinets, is backed by the Browning-Drake name and reputation. If your dealer cannot supply you, we will see that your requirements are filled.

DEALERS: The parts for the Official Browning-Drake should all be available from at least one distributor in your territory. If your jobber cannot supply you with all of the parts, we will tell you of one who can. Construction booklets for resale to your customers are now ready for distribution.

BROWNING-DRAKE CORPORATION, Brighton, Mass.